

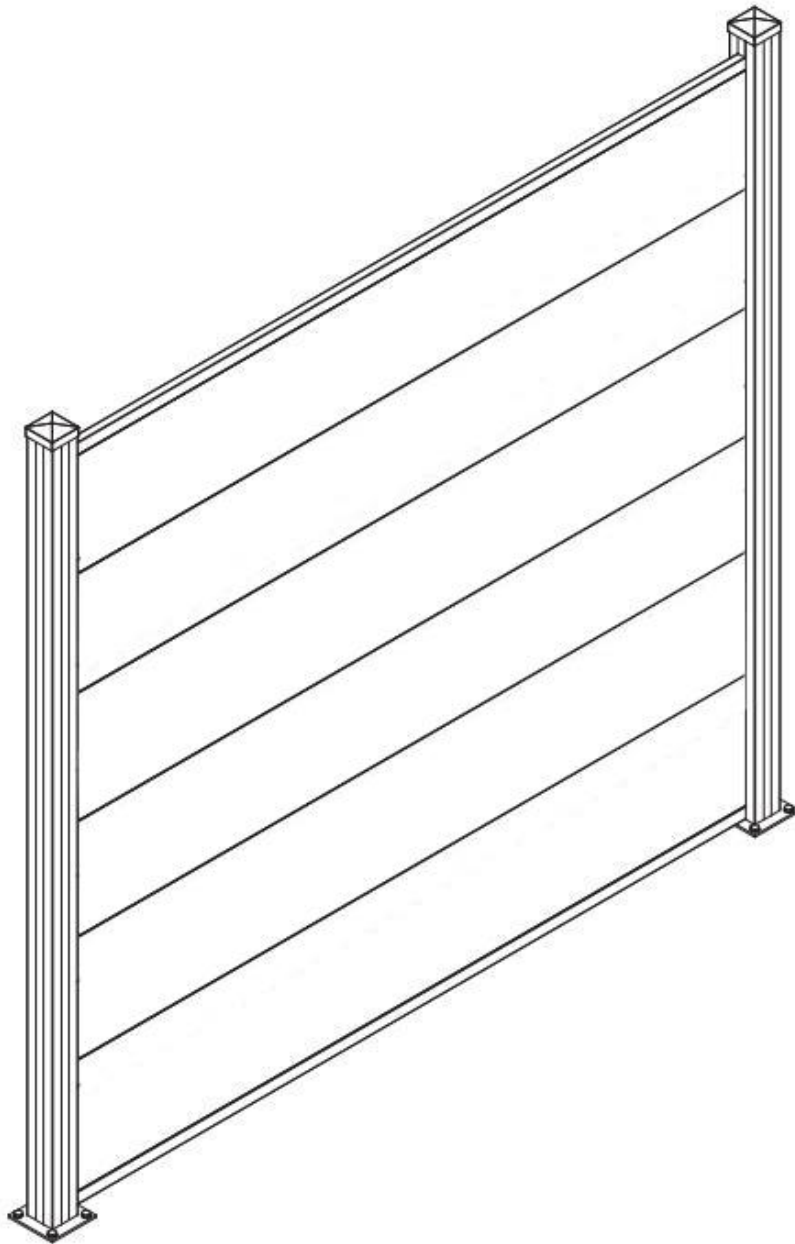

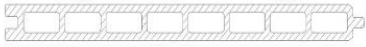

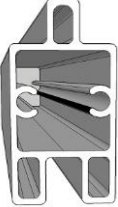

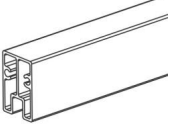

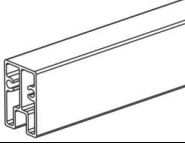
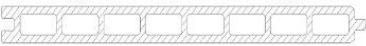

# Fence system

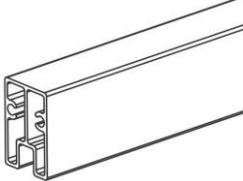
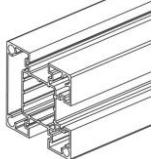
1377\_94085, 1377\_94086, 1377\_94087, 1377\_94093,  
1377\_94094, 1377\_97791, 1377\_97792, 1377\_97793,  
1377\_97794, 1377\_97795, 1377\_97796

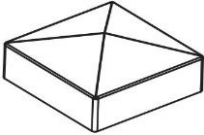
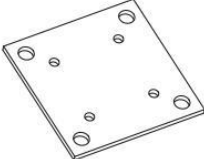
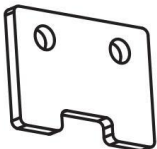

1377_94085				
A1		258x20x1600 mm	X 6	1/3
B		38X20X1590 mm	X 1	1/3
C		30X20X1590 mm	X 1	1/3
1377_94086				
A2		258x20x1600 mm	X 6	1/3
B		38X20X1590 mm	X 1	1/3
C		38X20X1590 mm	X 1	1/3
1377_94087				
A3		258x20x1600 mm	X 6	1/3
B		38X20X1590 mm	X 1	1/3
C		30X20X1590 mm	X 1	1/3

1377_94093				
D		70x70x1600 mm	X 1	2/3
E		21.79x11.28X1600 mm	X 1	2/3
1377_94094				
F		75X75 mm	X 1	3/3
G		130X130mm	X 1	3/3
H		25X18mm	X 4	3/3
I		26mm	X 8	3/3
J		80mm	X 4	3/3
K		80mm	X 4	3/3

FR : SAV/INFORMATION /CONTACT

EN : AFTER-SALES SERVICE/INFORMATION/CONTACT

DE : REPARATUR-SERVICE UND ERSATZTEILE /INFORMATIONEN /KONTAKT

ES : SERVICIO POST-VENTA/INFORMACIÓN/CONTACTO

IT : SERVIZIO ASSISTENZA/INFORMAZIONI/CONTATTO

PT : SERVIÇO PÓS-VENDA/INFORMAÇÕES/CONTATO

PL: SERWIS TECHNICZNY/INFORMACJE/KONTAKT

NE: AFTER SALES SERVICE/INFORMATIE/CONTACT

HE: עם לתקשר/הווידאו/ומכירות שירות לאחר

**SAV.HABITATETJARDIN.COM**

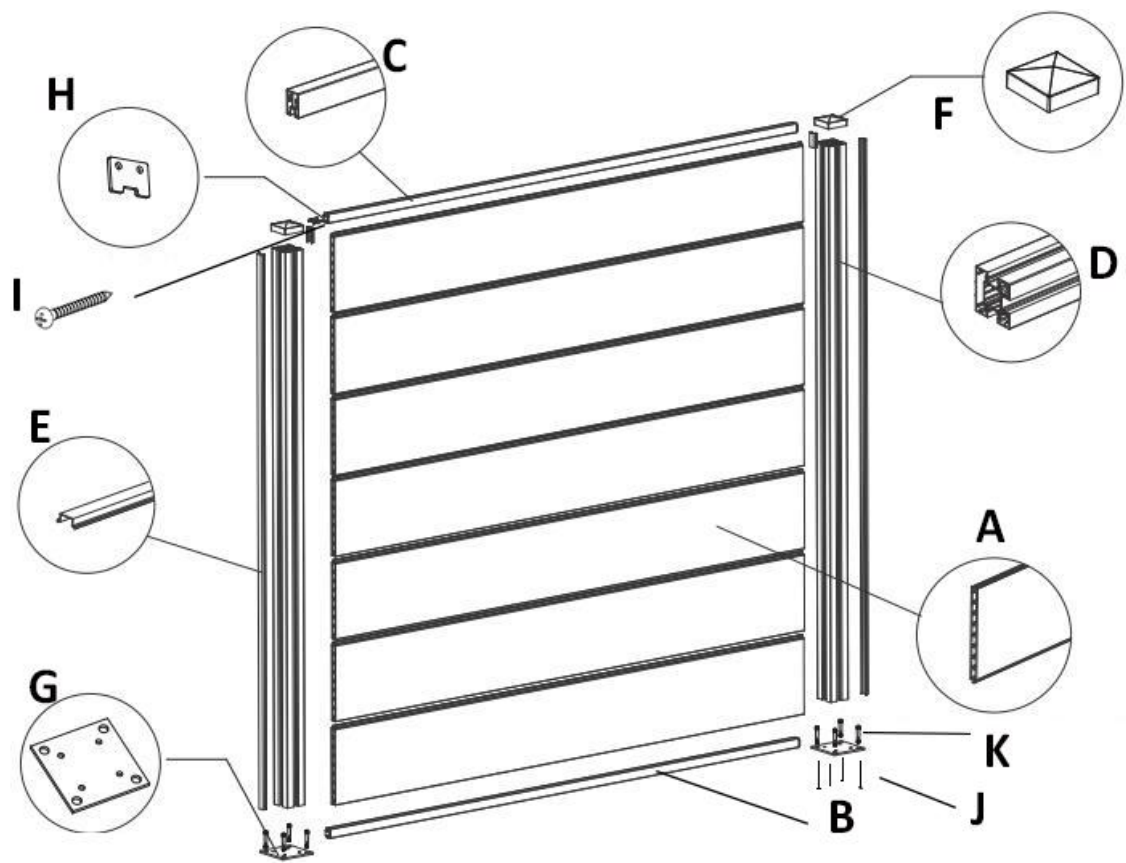

## FR

- Instructions :
- A la réception des lames, nous recommandons de les laisser reposer quelques jours pour qu'elles puissent s'adapter à la température de votre environnement avant de procéder à leur installation.
- 
- - Utilisation
- 1- L'utilisation de chlorure de sodium ou de sel pour faire fondre la neige ou la glace de la surface
- 2- Nettoyez les taches d'huile, de sauces et de nourriture avec des brosses et tissus.
- 3- Ne pas disposer les lames de terrasse près d'une source de chaleur pour éviter de les endommager.
- 
- - Lavage
- 1- N'utilisez pas de pelle en métal sur les lames pour retirer la neige de la surface
- 2- Il est recommandé de porter des chaussures lors du nettoyage et entretien des lames

## EN

- The warning instructions:
- when received your wpc boards, we recommend you allow them several days to adjust to your local temperature and conditions before starting installation work.
- 
- Utilisation warning
- 1. The use of sodium chloride or salt to melt the floor surface of snow and ice
- 2. Clean up oil, soy sauce and food with cleaners and brushes
- 3. Be careful not to get the board to be damaged by the heat source
- 
- Clean warning
- 1. Do not use metal shovel in the wpc board to clear the snow and sundries up
- 2. It is recommended to wear shoes when cleaning and maintaining
-

- The assembly instructions

