

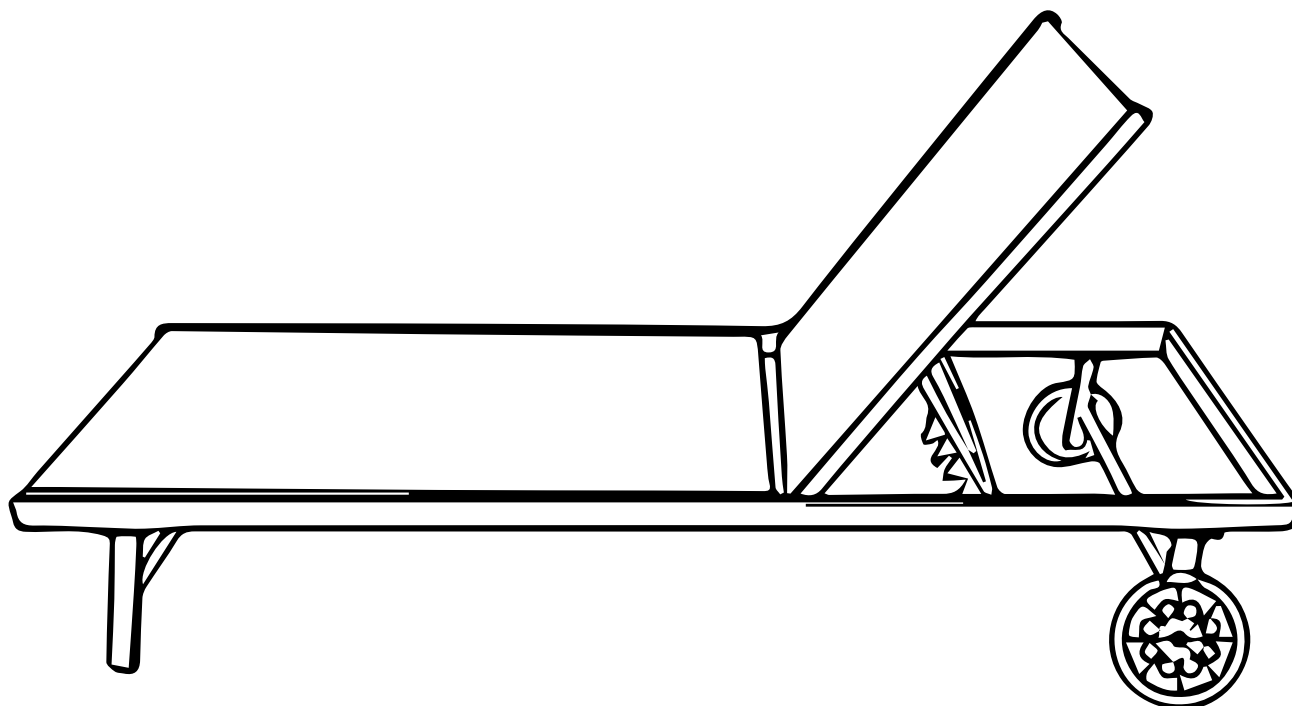







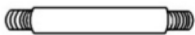

# BELLA

1288\_78550/1288\_78551/1288\_78552/1288\_78555/1288\_78556  
1288\_93757/1288\_93756/1288\_93758

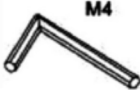

1288\_78550/1288\_78551/1288\_78552/1288\_78555/1288\_78556  
1288\_93757/1288\_93756/1288\_93758

A		650x300x90mm	X 1	1/1
B		650x215x90mm	X 1	1/1
C		φ230x50mm	X 2	1/1
D		φ12x92mm	X 2	1/1
E		21/10.5X1.5mm	X 4	1/1
F		6x15mm	X 8	1/1
G		M10	X 4	1/1
H		M6	X 1	1/1
I		2000x650x100mm	X 1	1/1
J		pièce déjà installée sur les pieds et sur l'assise	X 12	1/1

FR : SAV/INFORMATION /VIDEO/CONTACT

EN: AFTER-SALES SERVICE/INFORMATION/VIDEO/CONTACT

DE : REPARATUR-SERVICE UND ERSATZTEILE /INFORMATIONEN /VIDEO/KONTAKT

ES: SERVICIO POST-VENTA/INFORMACIÓN/VIDEO/CONTACTO

IT: SERVIZIO ASSISTENZA/INFORMAZIONI/VIDEO/CONTATTO

PT: SERVIÇO PÓS-VENDA/INFORMAÇÕES/VIDEO/CONTATO

PL: SERWIS TECHNICZNY/INFORMACJE/WIDEO/KONTAKT

NE: AFTER SALES SERVICE/INFORMATIE/VIDEO/CONTACT

HE: מע רשקתל/ואדיווה/ עדימ/תורכימו תוריש רחאל

SAV.HABITATETJARDIN.COM

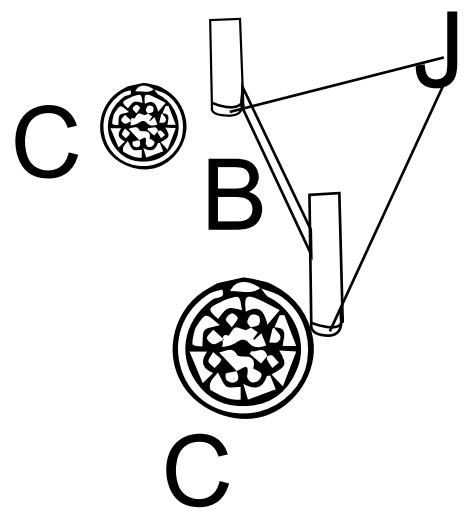
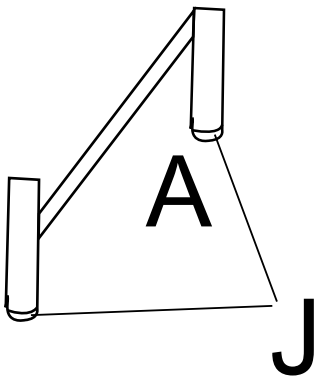
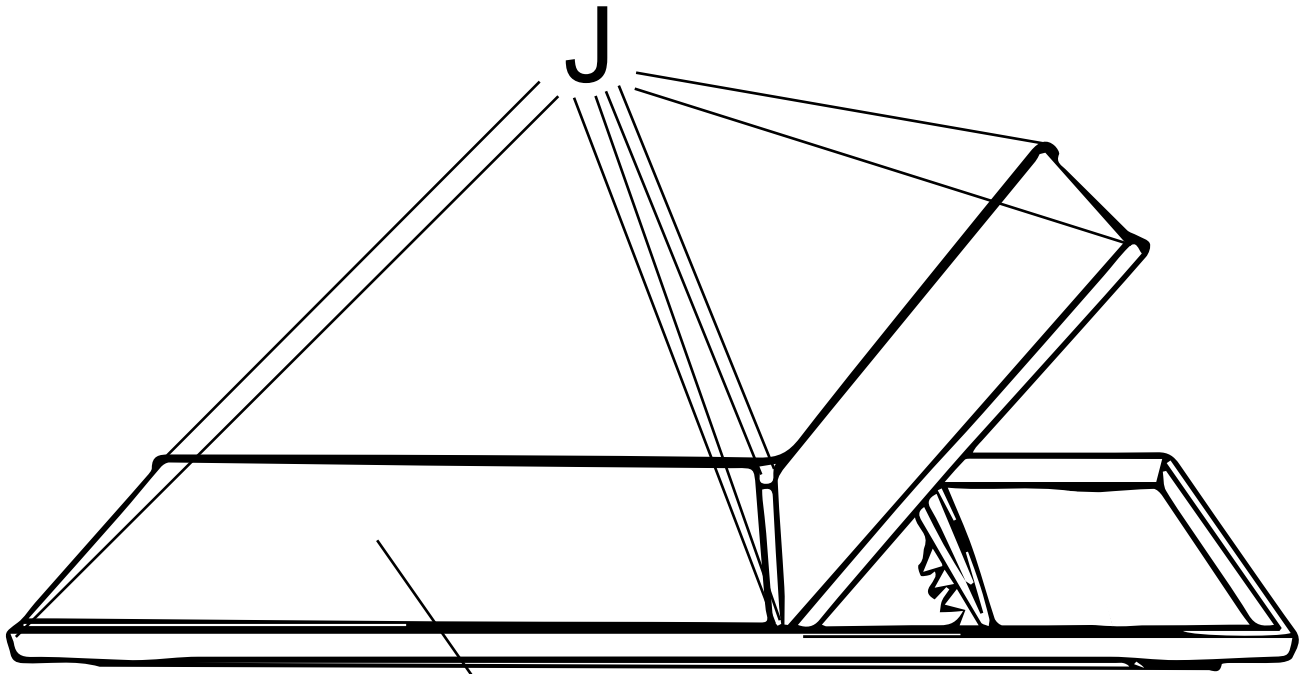

## FR

- Il est conseillé d'attendre d'avoir monté entièrement votre produit avant de serrer complètement vos vis.
- Il est conseillé de protéger vos produits à l'aide d'une housse de protection afin de les préserver des intempéries et de la poussière.
- Séchez votre mobilier aussi tôt pour éviter les traces.
- En hiver, stockez vos produits à l'abri dans un endroit sec.
- Ne jamais utiliser des produits chimiques pour le nettoyage.

## EN

- It is advisable to wait until you have fully assembled your product before tightening your screws completely.
- It is advisable to put your products into cover to protect them from the severe weather and dust.
- Dry your furniture as early as possible to avoid traces.
- In winter, store your products in a dry place.
- Never use chemical products for cleaning.

## DE

- Es ist ratsam, für Ihre vollständig montiert zu warten, bevor vollständig Ihre Schrauben festziehen.
- Es wird empfohlen, Ihre Produkte mit einer Schutzabdeckung zum Schutz vor Witterung und Staub zu schützen.
- Trocknen Sie Ihre Möbel zu früh Spek zu verhindern.
- Im Winter, speichern Sie Ihre Waren an einem trockenen Ort.
- Verwenden Sie niemals Chemikalien zur Reinigung.

## ES

- Se aconseja montar totalmente el producto antes de apretar completamente todos los tornillos.
- Se aconseja cubrir los productos con una funda para protegerlos de las intemperies y del polvo.
- Seque inmediatamente su mobiliario para evitar las marcas.
- En invierno, almacene los productos en un lugar seco.
- Nunca utilice productos químicos para la limpieza.

## IT

- È consigliato di aspettare di avere montato interamente il prodotto prima di stringere completamente le viti.
- È consigliato di proteggere i prodotti con un sacco di protezione per preservarli dal brutto tempo e dalla polvere.
- Subito asciugare i prodotti per non avere tracce.
- Durante l'inverno, mettere i prodotti al riparo in un luogo secco.
- Mai usare prodotti chimici per pulire i prodotti.

①

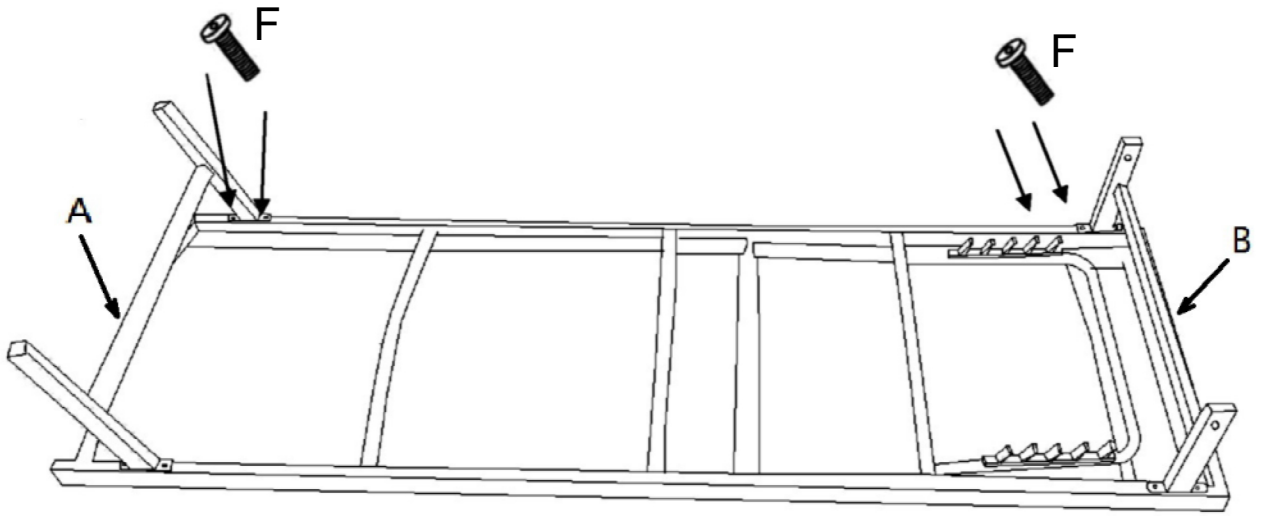

②

