

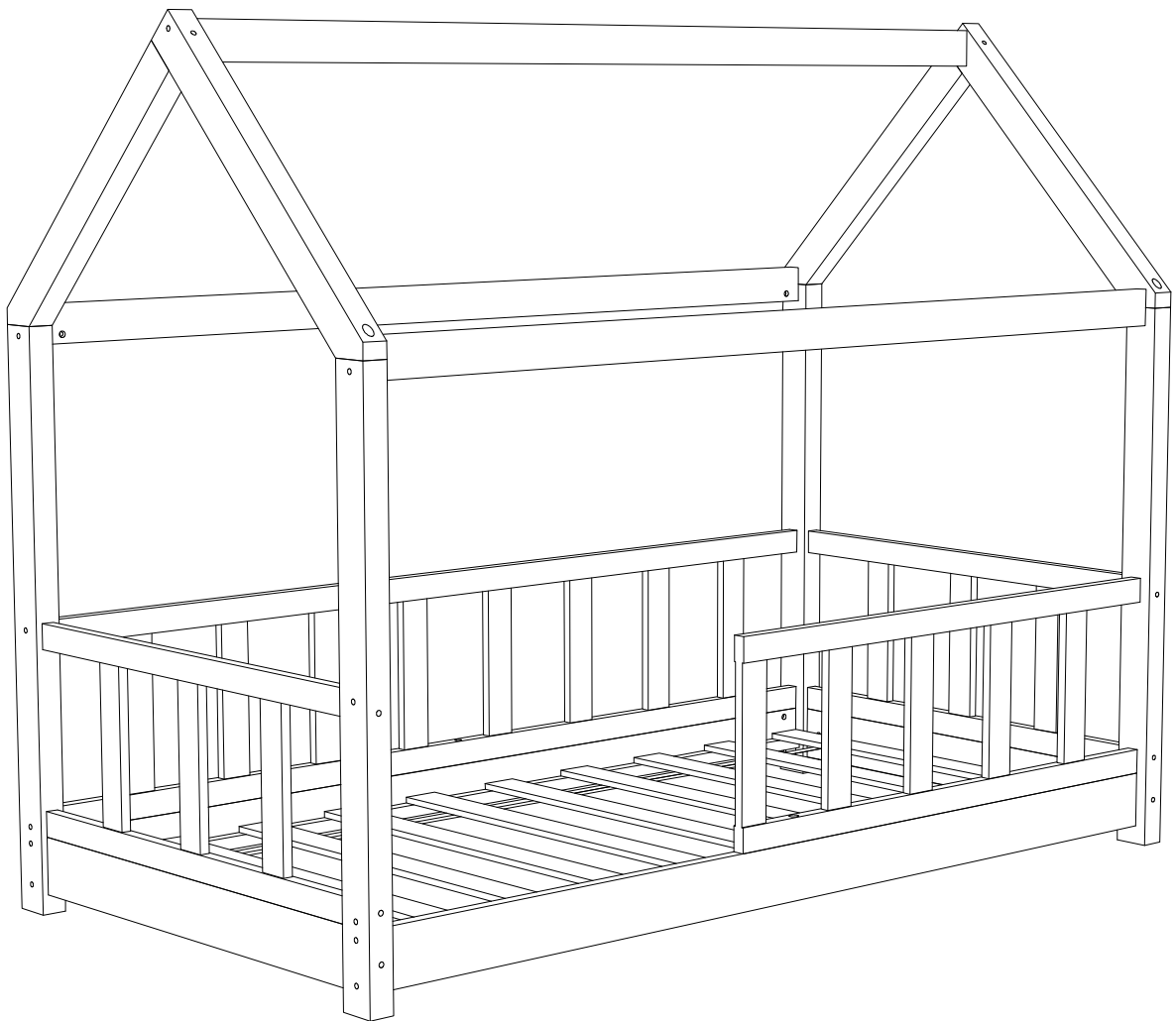

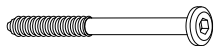

Charlotte

1548_135114

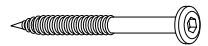
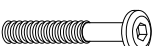
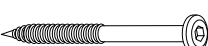

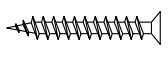
1548_135114

A		M6*100MM	X4PC	1 / 1	E		Φ6*80MM	X12PC	1 / 1
B		M6*80MM	X14PC	1 / 1	F		Φ6*100MM	X10PC	1 / 1
C			X18PC	1 / 1	G		Φ4*30MM	X20PC	1 / 1
D		Φ8*30MM	X24PC	1 / 1	H		4MM	X1PC	1 / 1

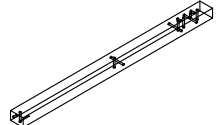
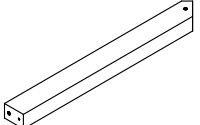
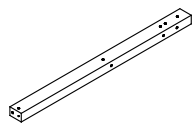
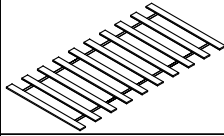
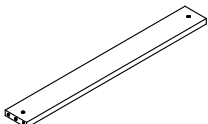
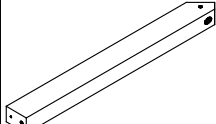
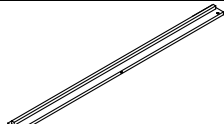
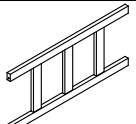
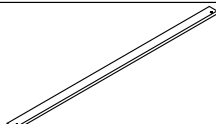
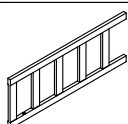
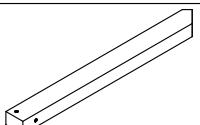
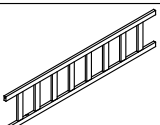
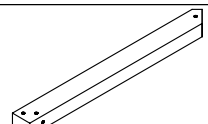
1		900*60*40	X2PC	1 / 1	8		580*60*40	X1PC	1 / 1
2		900*60*40	X2PC	1 / 1	9		799*60*13	X10PC	1 / 1
3		760*90*20	X2PC	1 / 1	10		580*60*40	X1PC	1 / 1
4		1580*90*20	X2PC	1 / 1	11		770*330*20	X2PC	1 / 1
5		1580*60*20	X3PC	1 / 1	12		916*330*20	X1PC	1 / 1
6		640*60*40	X1PC	1 / 1	13		1600*330*20	X1PC	1 / 1
7		640*60*40	X1PC	1 / 1					

FR : SAV/INFORMATION /VIDEO/CONTACT

EN: AFTER-SALES SERVICE/INFORMATION/VIDEO/CONTACT

DE : REPARATUR-SERVICE UND ERSATZTEILE /INFORMATIONEN /VIDEO/KONTAKT

ES: SERVICIO POST-VENTA/INFORMACION/VIDEO/CONTACTO

IT: SERVIZIO ASSISTENZA/INFORMAZIONI/VIDEO/CONTATTO

PT: SERVIÇO PÓS-VENDA/INFORMAÇÕES/VIDEO/CONTATO

PL: SERWIS TECHNICZNY/INFORMACJE/WIDEO/KONTAKT

NE: AFTER SALES SERVICE/INFORMATIE/VIDEO/CONTACT

HE: מע רשקתל/ואדיוור / עדימ/תורכימו תוריש רחאל



SAV.HABITATETJARDIN.COM

2/5
2022-2023

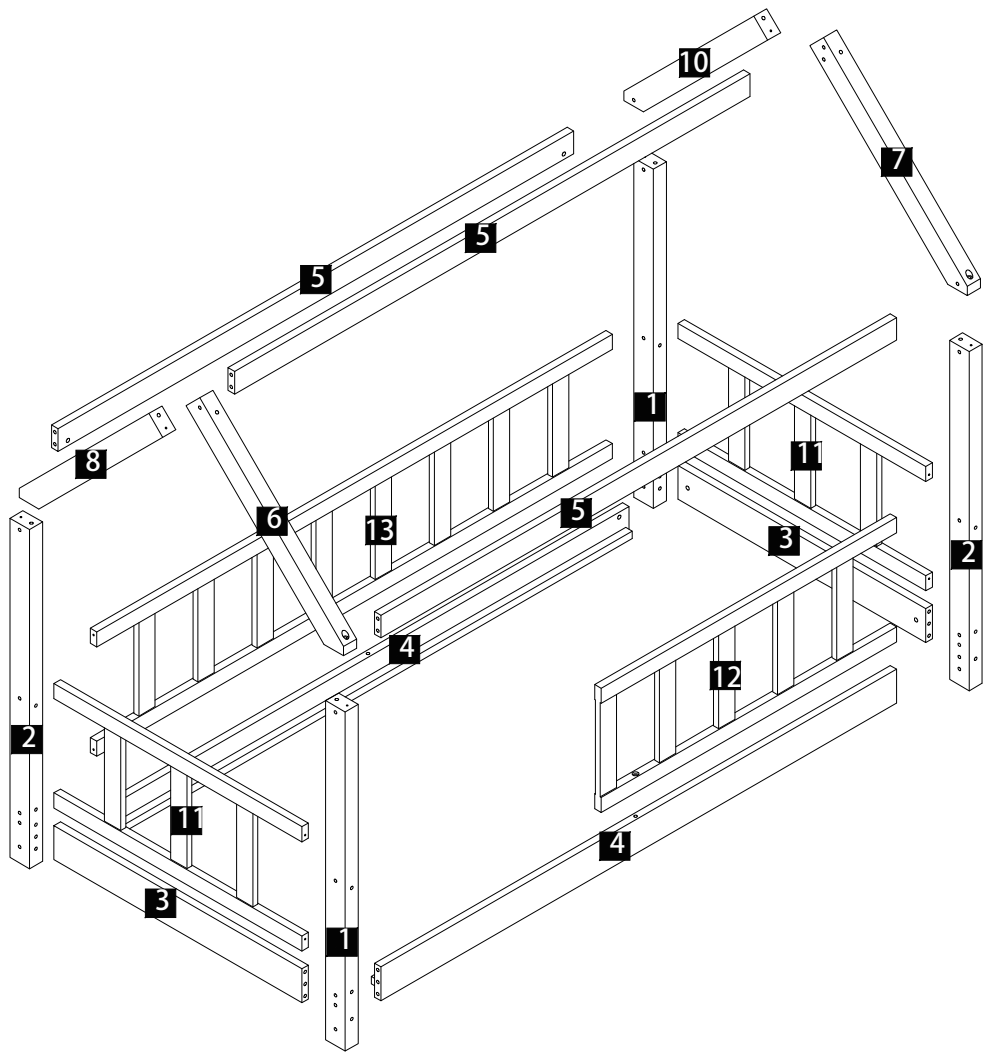
STEP:1



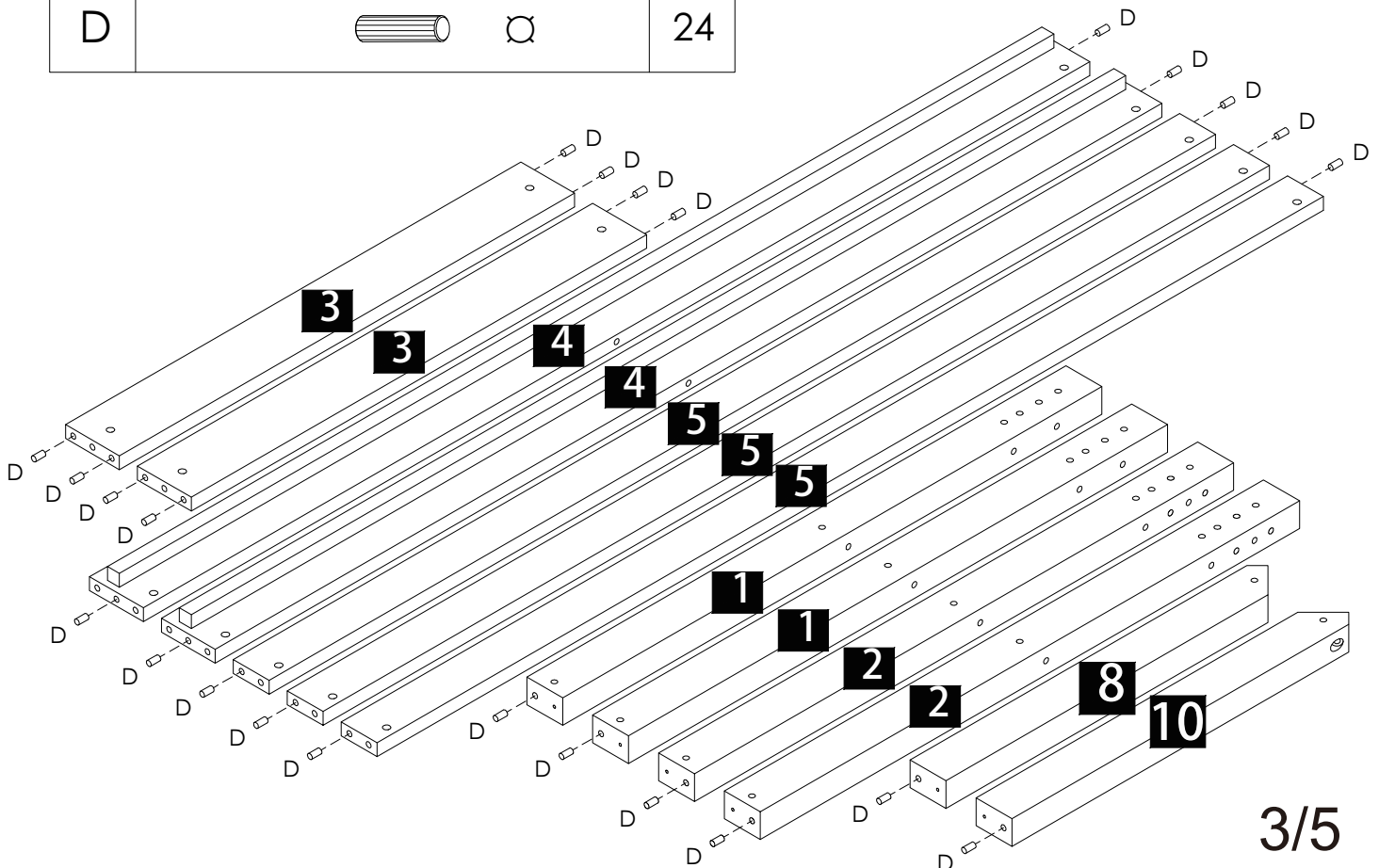

STEP:2

D			24
---	---	---	----



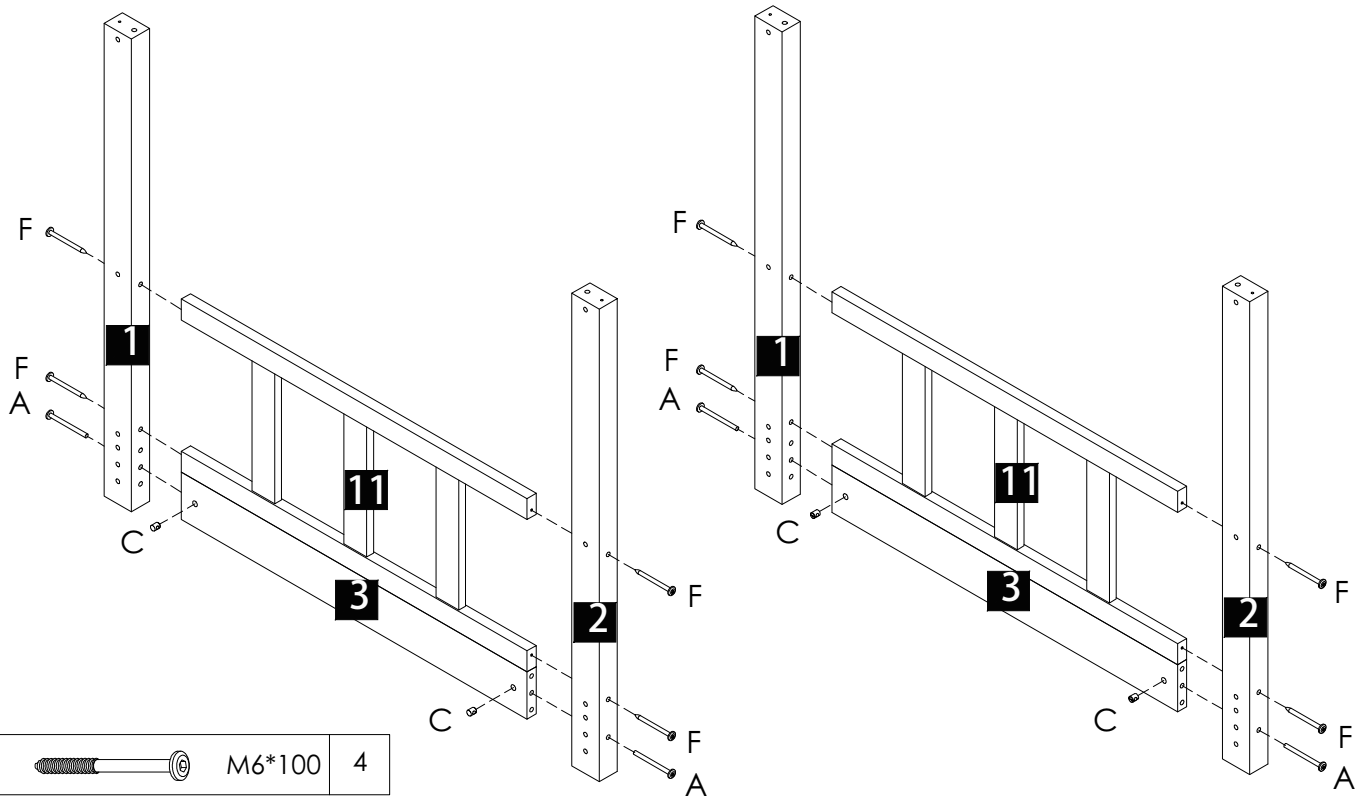

STEP:3

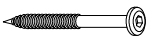

A		M6*100	4
C			4
F		Ø 100	8

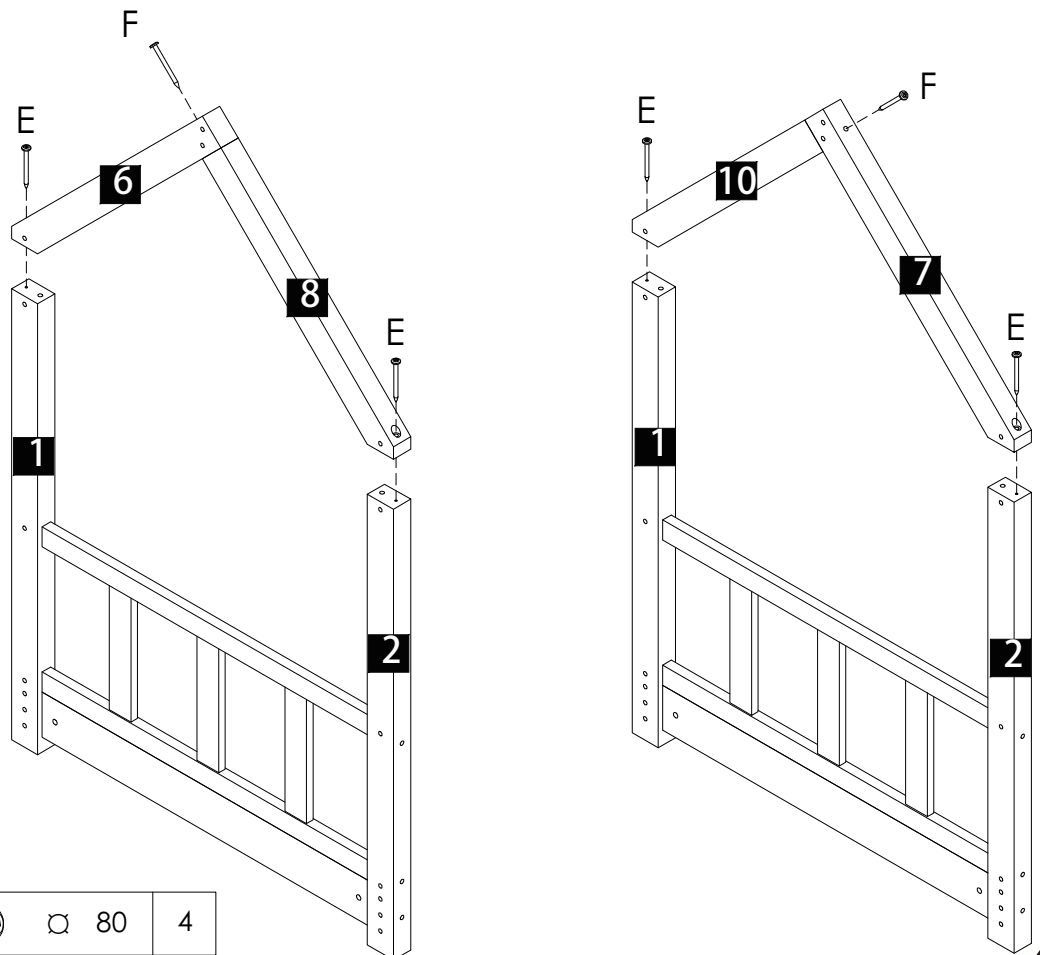

STEP:4

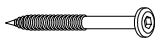

E		Ø 80	4
F		Ø 100	2

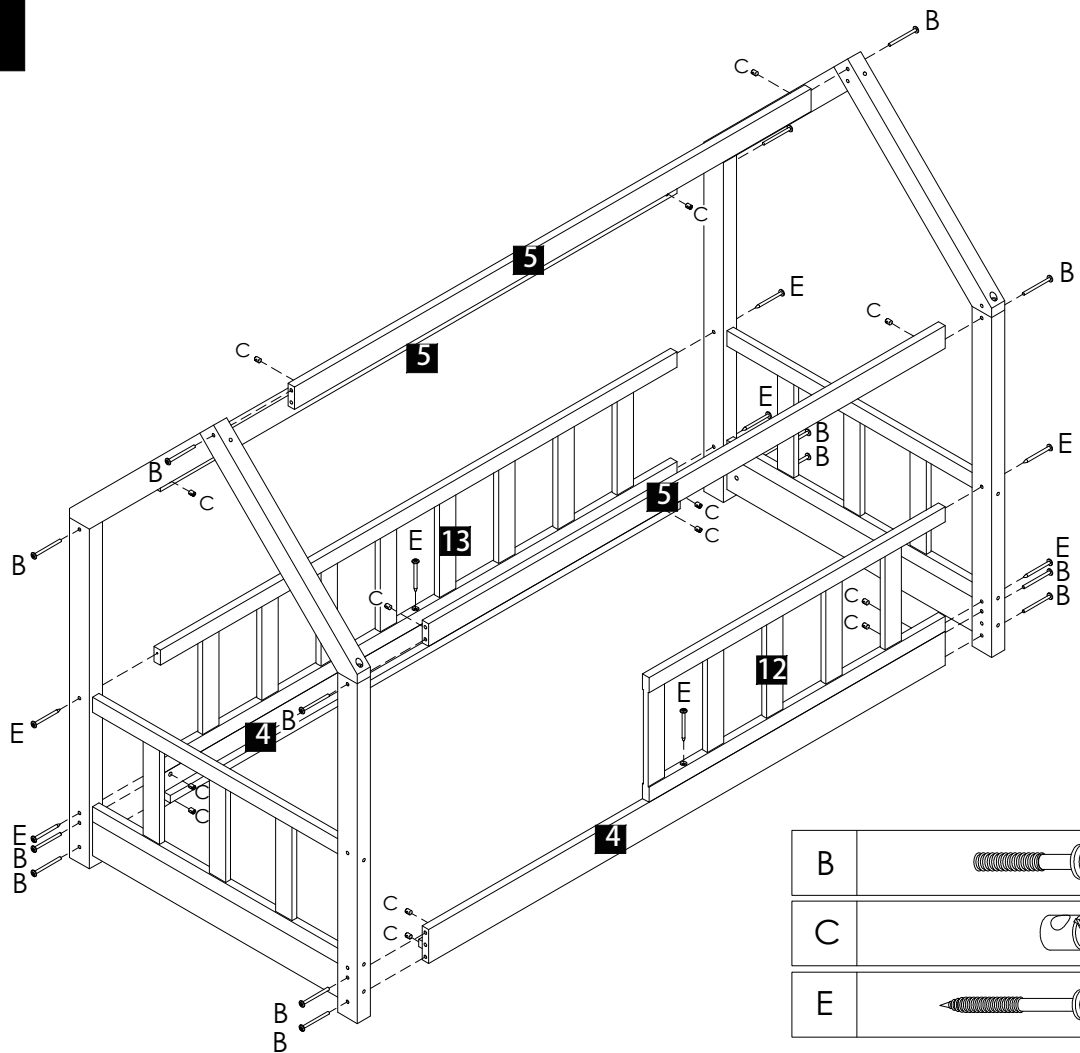
STEP:5

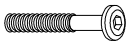

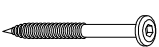
B		M6*80	14
C			14
E		Ø 80	8

STEP:6

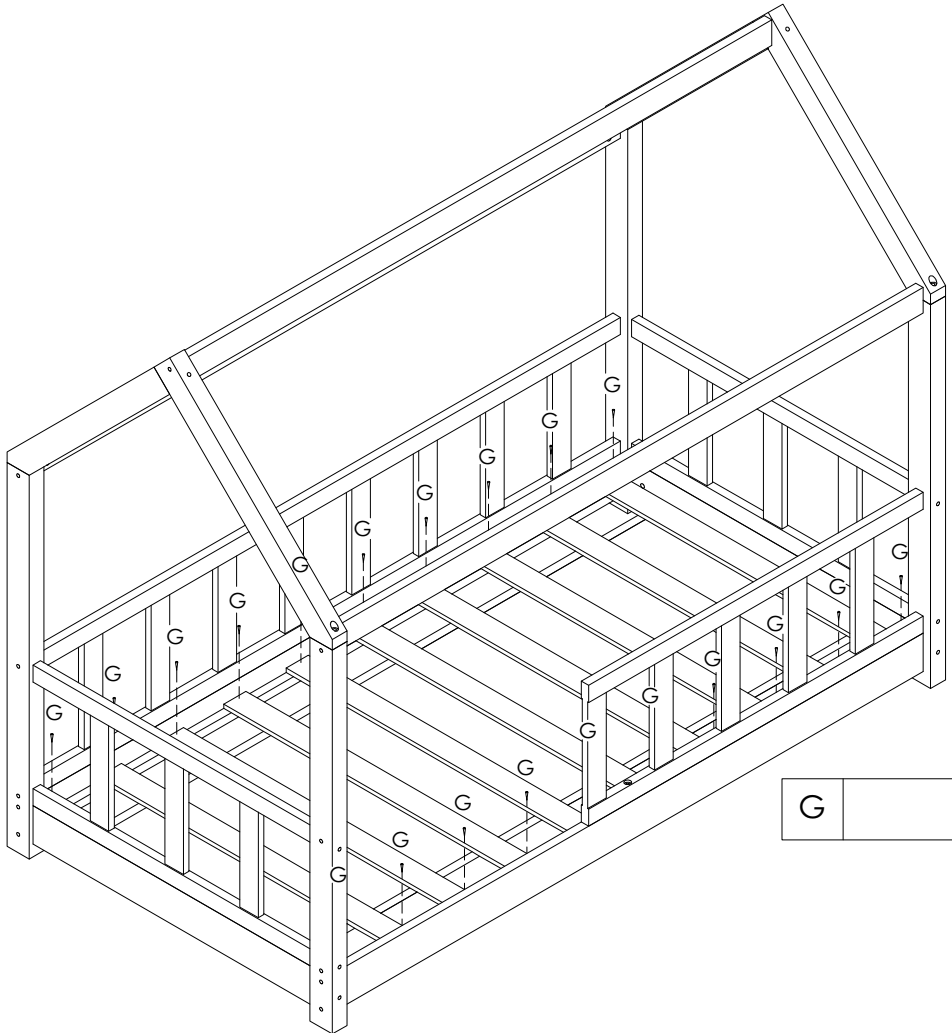

G		4*30	20
---	---	------	----