

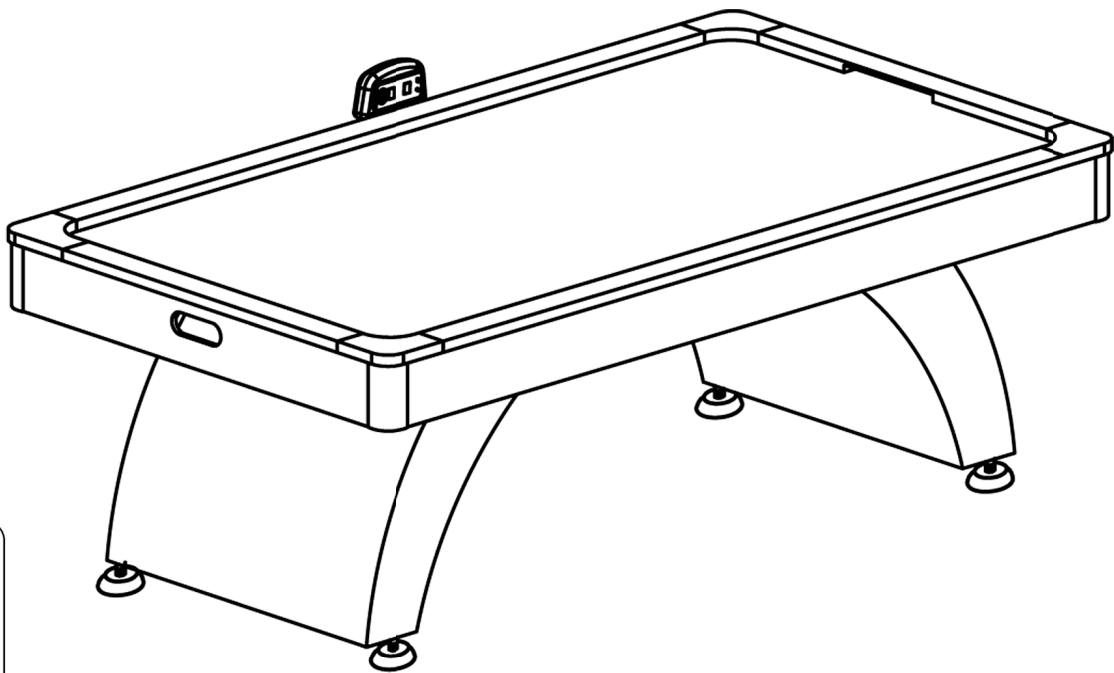

Merci de recycler cet emballage!
Please recycle the package. Thanks!

MANUEL D'ASSEMBLAGE ASSEMBLY INSTRUCTIONS







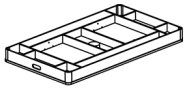
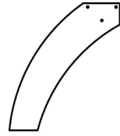
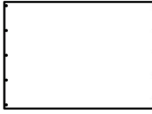

Avant la première utilisation, veuillez lire la notice de montage !

TABLE DE AIR HOCKEY

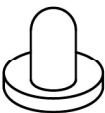

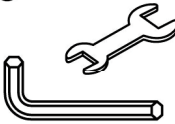
INDEX DES PIÈCES

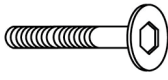
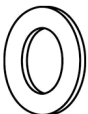
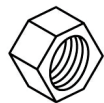
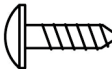
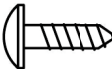
<p>P1</p>  <p>Structure principale Main structure 1 PC</p>	<p>P2</p>  <p>Pied Leg 4 PCS</p>	<p>P3</p>  <p>Panneau de pied Leg panel 4 PCS</p>	<p>P4</p>  <p>Pied ajustable Leg leveler 4 PCS</p>	
<p>A1</p>  <p>Buteur Hockey striker 2 PCS</p>	<p>A2</p>  <p>Palet Hockey puck 2 PCS</p>	<p>A3</p>  <p>Outil Tool 2 PCS</p>	<p>A4</p>  <p>Compteur électronique Electronic scorer 1 PC</p>	<p>A5</p>  <p>Pile Battery 4 PCS</p>
<p>H1</p>  <p>Boulon 5/16x2" 5/16x2" Bolt 12 PCS</p>	<p>H2</p>  <p>Rondelle 5/16" 5/16" Washer 24 PCS</p>	<p>H3</p>  <p>Ecrou Lock hex nut 12 PCS</p>	<p>H4</p>  <p>Vis Screw 40 PCS</p>	<p>H5</p>  <p>Vis Screw 3 PCS</p>

MONTAGE

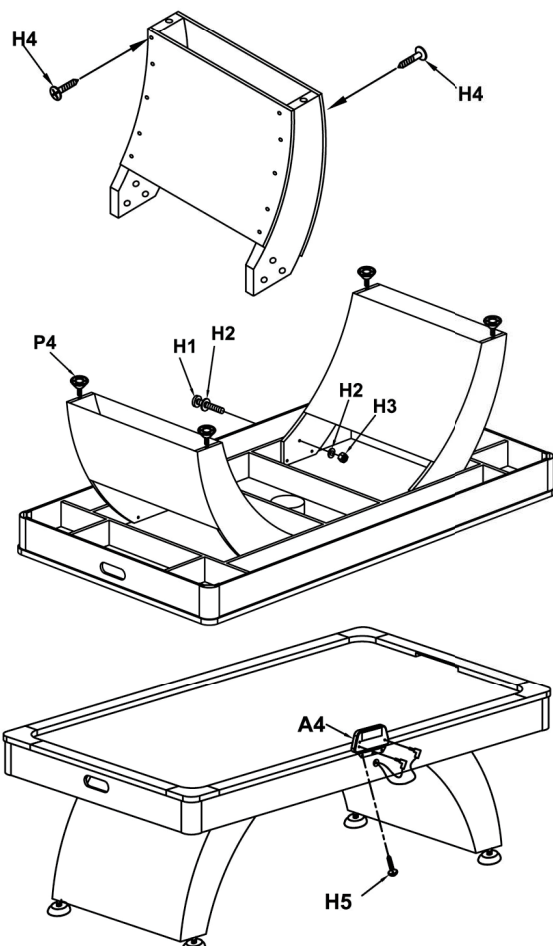

Étape 1 / Step 1 : Fixez les panneaux de pied (P3) aux pieds (P2) à l'aide des vis (H4).

Étape 2 / Step 2 : Fixez chaque pied à la structure principale (P1) à l'aide des boulons (H1), des rondelles (H2) et des écrous (H3). Fixez les pieds ajustables (P4).

Étape 3 / Step 3 : Fixez le compteur électronique (A4) à l'aide des vis (H5).