

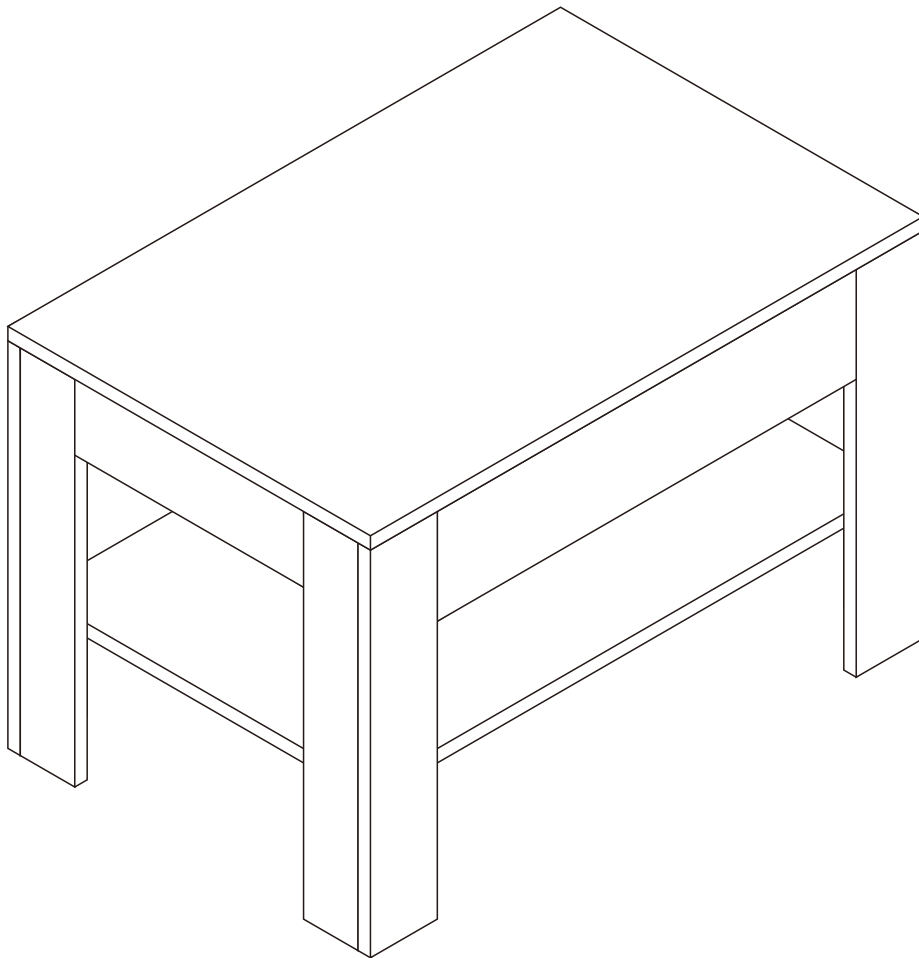

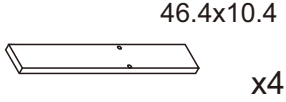



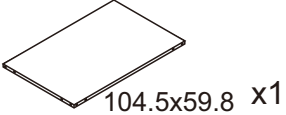
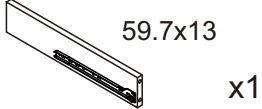
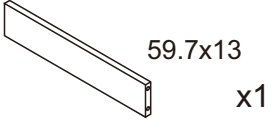
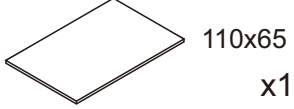
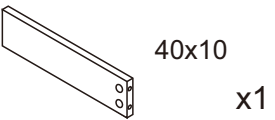
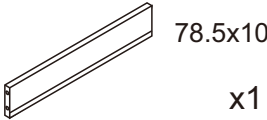

# Joy

1417\_103815

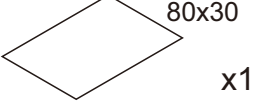
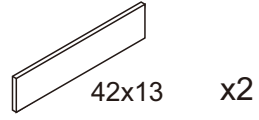

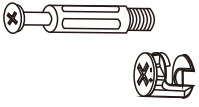
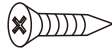
| 1417_103815 |   |     |    |  |     |
|-------------|---|-----|----|--|-----|
| A           |  46.4x10.4<br>x4 | 1/1 | B  |  46.4x12<br>x4   | 1/1 |
| C           |  104.5x59.8 x1   | 1/1 | D  |  59.7x13<br>x1   | 1/1 |
| E           |  59.7x13<br>x1   | 1/1 | F  |  110x65<br>x1    | 1/1 |
| G           |  40x10<br>x1     | 1/1 | H  |  78.5x10<br>x1   | 1/1 |
| J           |  40x10<br>x1     | 1/1 | K  |  80x30<br>x1     | 1/1 |
| L           |  42x13 x2       | 1/1 | M. |  84x15<br>x1    | 1/1 |
| a           |  x54           | 1/1 | b  |  x8            | 1/1 |
| c           |  x2            | 1/1 | l  |  83.7x15<br>x1 | 1/1 |

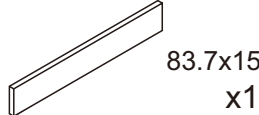
FR : SAV/INFORMATION /VIDEO/CONTACT

EN: AFTER-SALES SERVICE/INFORMATION/VIDEO/CONTACT

DE : REPARATUR-SERVICE UND ERSATZTEILE /INFORMATIONEN /VIDEO/KONTAKT

ES: SERVICIO POST-VENTA/INFORMACI N/VIDEO/CONTACTO

IT: SERVIZIO ASSISTENZA/INFORMAZIONI/VIDEO/CONTATTO

PT: SERVIÇO P S-VENDA/INFORMAÇÕES/VIDEO/CONTATO

PL: SERWIS TECHNICZNY/INFORMACJE/WIDEO/KONTAKT

NE: AFTER SALES SERVICE/INFORMATIE/VIDEO/CONTACT

HE: מע רשקתל/ואדיווה/ עדימ/תורכמו תוריש רחאל

**SAV.HABITATETJARDIN.COM**

