

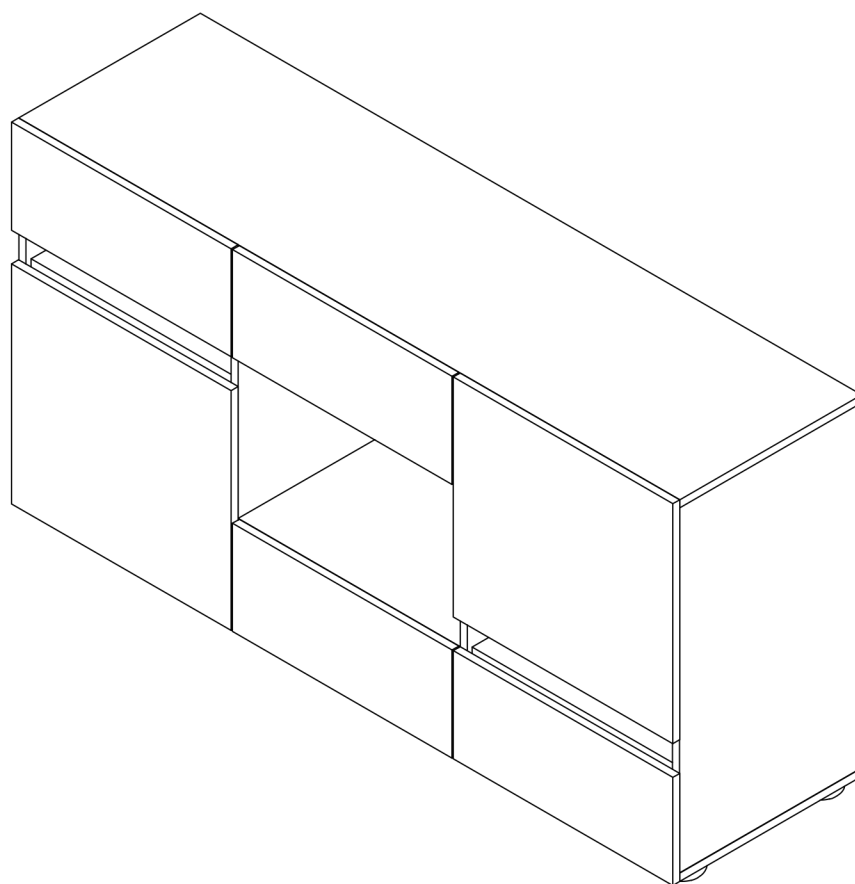









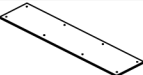

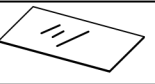

























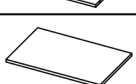

# VOLTA

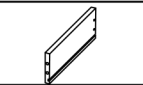
1335\_85394



|    |   |             |    |     |          |  |           |     |     |
|----|---|-------------|----|-----|----------|--|-----------|-----|-----|
| 1  |    | 1400*385*15 | x1 | 1/2 | 22       |    | 424*293*5 | x1  | 2/2 |
| 2  |    | 1400*385*15 | x1 | 1/2 | 23       |    | 451*370*5 | x1  | 2/2 |
| 3  |    | 670*365*15  | x1 | 1/2 | 24       |    | 416*370*5 | x1  | 2/2 |
| 4  |    | 670*365*15  | x1 | 1/2 | 25       |    |           | x1  | 2/2 |
| 5  |    | 1369*223*15 | x1 | 1/2 | 26<br>27 |    | 10"       | x2  | 2/2 |
| 6  |    | 1369*80*15  | x1 | 1/2 | 28       |    | Ø5*40     | x58 | 2/2 |
| 7  |    | 1379*399*5  | x1 | 1/2 | 29       |    | Ø3.5*12   | x56 | 2/2 |
| 8  |    | 670*385*15  | x1 | 1/2 | 30       |    | Ø3.5*35   | x4  | 2/2 |
| 9  |    | 670*385*15  | x1 | 1/2 | 31       |    | Ø15*13    | x58 | 2/2 |
| 10 |    | 430*110*5   | x2 | 2/2 | 32       |    | Ø35       | x1  | 2/2 |
| 11 |   | 465*440*15  | x1 | 2/2 | 33       |   | Ø6*30     | x32 | 2/2 |
| 12 |  | 465*440*15  | x1 | 2/2 | 34       |  | Ø75*20    | x8  | 2/2 |
| 13 |  | 465*198*15  | x1 | 2/2 | 35       |  | Ø6*25     | x8  | 2/2 |
| 14 |  | 465*198*15  | x1 | 2/2 | 36       |  | Ø6*10     | x12 | 2/2 |
| 15 |  | 465*198*15  | x1 | 2/2 | 37       |  |           | x8  | 2/2 |
| 16 |  | 465*198*15  | x1 | 2/2 | 38       |  |           | x8  | 2/2 |
| 17 |  | 434*354*15  | x3 | 2/2 | 39       |  | Ø3.5*18   | x8  | 2/2 |
| 18 |  | 470*365*15  | x1 | 2/2 | 40       |  | Ø3*12     | x21 | 2/2 |
| 19 |  | 414*100*15  | x1 | 2/2 | 41       |  |           | x1  | 2/2 |
| 20 |  | 300*100*15  | x1 | 2/2 | 42       |  |           | x3  | 2/2 |
| 21 |  | 300*100*15  | x1 | 2/2 | 43       |  |           | x3  | 2/2 |

FR : SAV/INFORMATION /VIDEO/CONTACT

EN: AFTER-SALES SERVICE/INFORMATION/VIDEO/CONTACT

DE : REPARATUR-SERVICE UND ERSATZTEILE /INFORMATIONEN /VIDEO/KONTAKT

ES: SERVICIO POST-VENTA/INFORMACIÓN/VIDEO/CONTACTO

IT: SERVIZIO ASSISTENZA/INFORMAZIONI/VIDEO/CONTATTO

PT: SERVIÇO PÓS-VENDA/INFORMAÇÕES/VIDEO/CONTATO

PL: SERWIS TECHNICZNY/INFORMACJE/VIDEO/KONTAKT

NE: AFTER SALES SERVICE/INFORMATIE/VIDEO/CONTACT

HE: לתקשר עם/הווידיאו/ מידע/לאחר שירות ומכירות

**SAV.HABITATETJARDIN.COM**

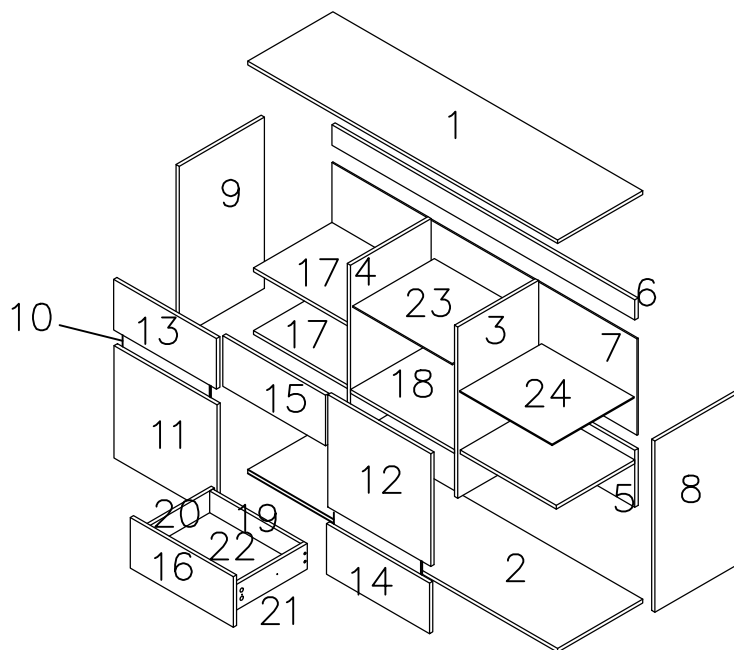
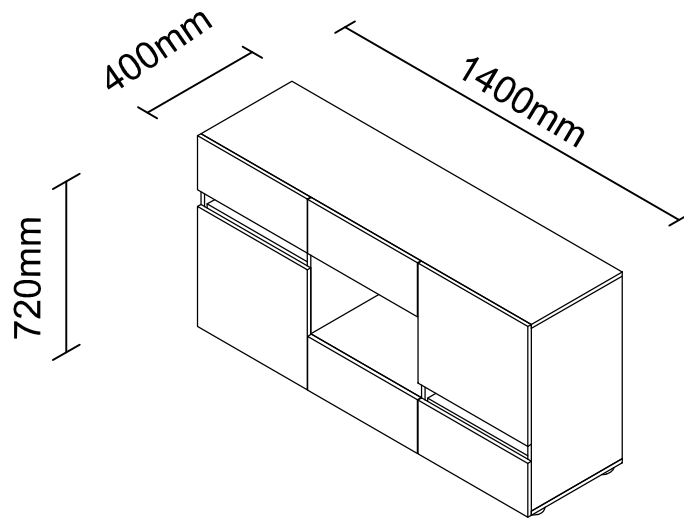

1

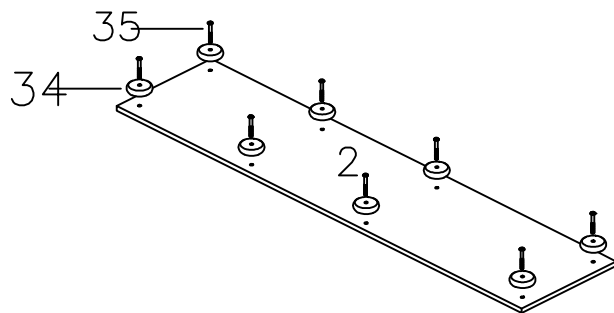

2

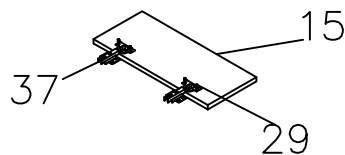
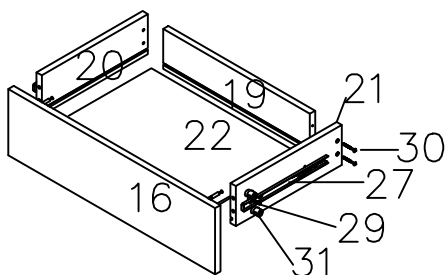
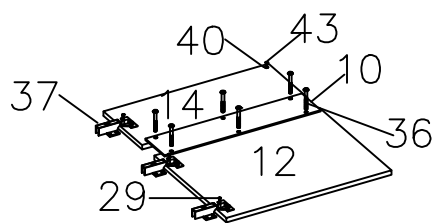
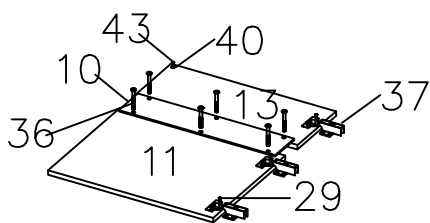

3

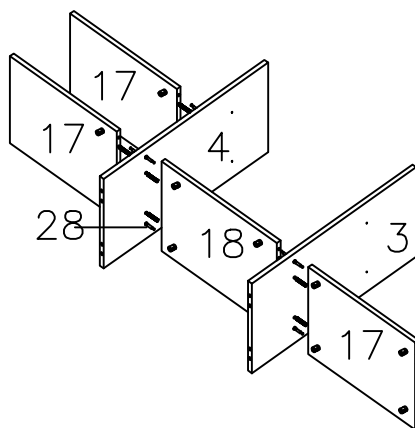

4

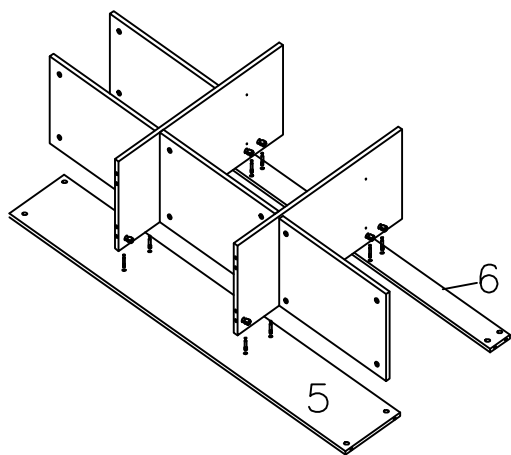

5

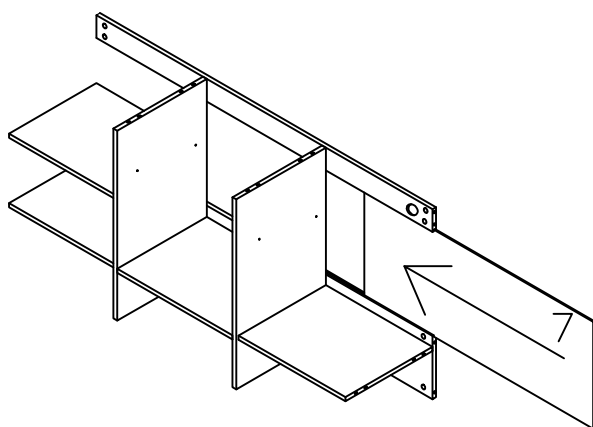

6

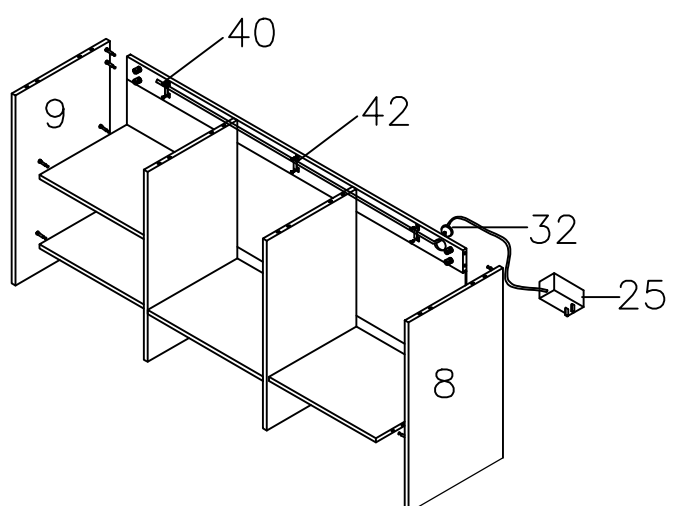

7

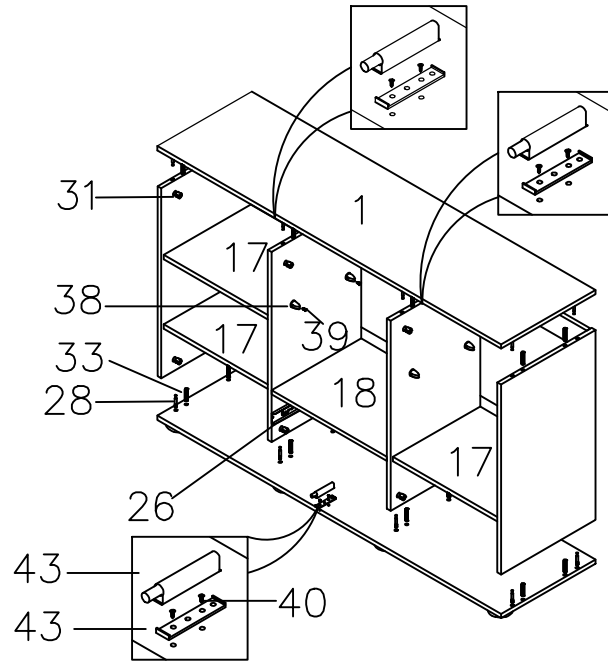

8

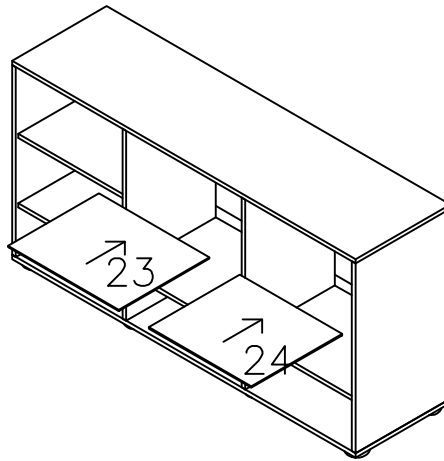

9

