

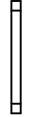

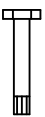





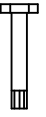

# LISTE DE PIECE

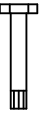
## Pièces de montage

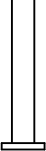
DESCRIPTION	QTE, REQUIS
 [H1] Support de pied	4
 [H2] Vis M8x50	4
 [H3A] Anneaux plastique	4
 [H3B] Anneaux plastique	8
 [H4] Vis M8x85	4
 [H5] Boulon M8	8
 [H6] Rondelle Ø8	8
 [H7] Vis M10x55	4
 [H8] Rondelle Ø10	4
 [H9] Pied en T	4
 [H10] Connection	2
 [H11] Roue	8
 [H12] Raquette	2
 [H13] Filet	1

# NOTICE DE MONTAGE

MODELE:1282\_68020

1. Ce produit est composé de deux cois. Dans un cois, vous pouvez trouver le plateau de la table, les supports de pied en forme de H, deux pièces de connections afin d'assembler le cadre du support. Dans le deuxième cois, vous trouverez 4 barres en forme T qui forment le châssis de support avec les roues.

2. Instruction :

- Prévoir deux adultes pour le montage.
- Après avoir ouvert le carton, posez le plateau à l'envers sur le carton
- Prenez deux pièces de connections (en forme de H) et libérez les boulons sur les deux côté de la barre?  
**H3 ATTENTION LA DIRECTION DE PIECE**

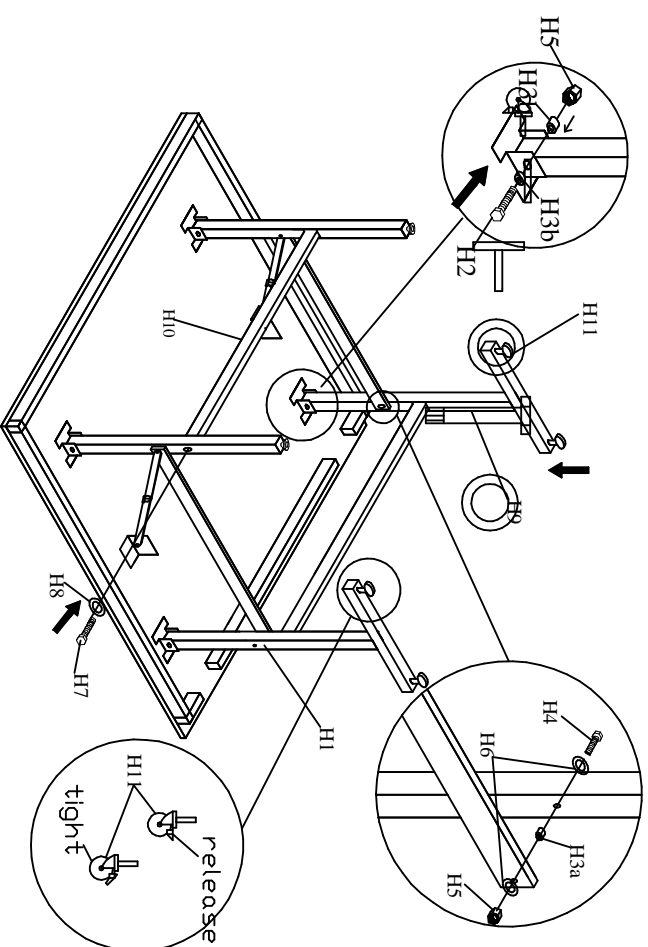

**AVERTISSEMENT:**  
AU MOINS DEUX ADULTS POUR LE MONTAGE

# NOTICE DE MONTAGE

---

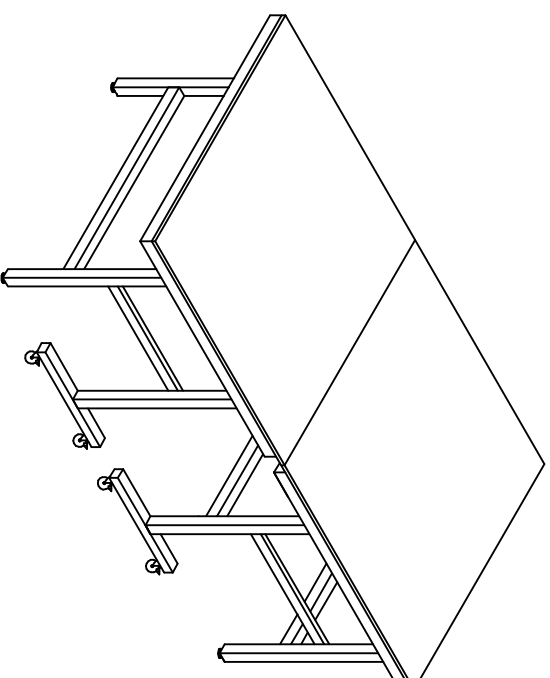
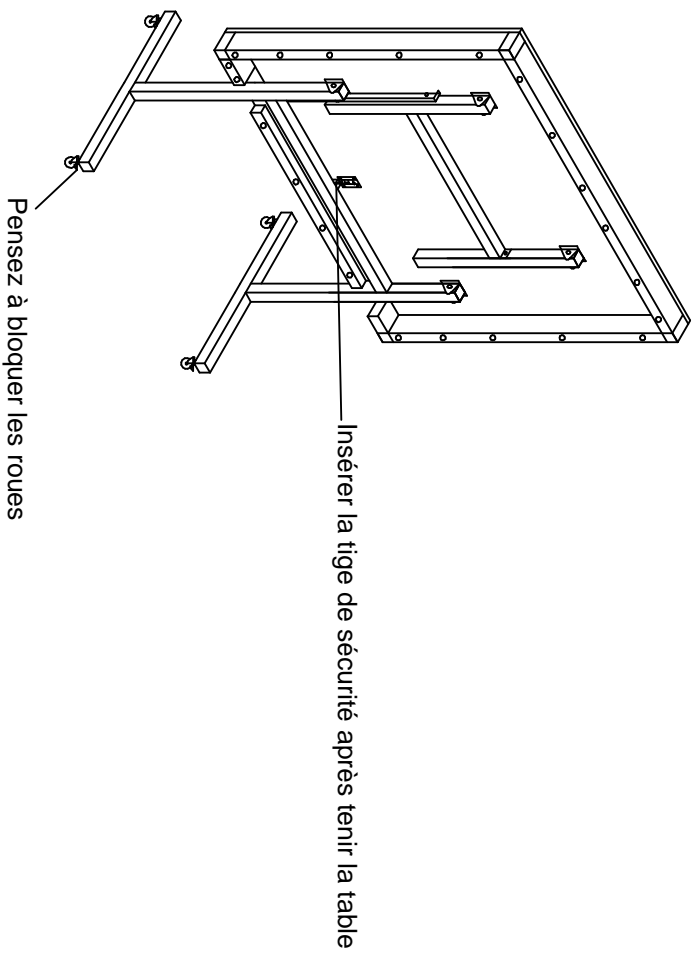

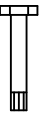

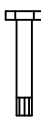

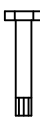

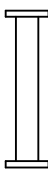

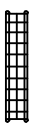

PHOTO APRES MONTAGE

# PARTS IDENTIFIER

## HARDWARE

sketch	Index name	spec	quantity
	H1	shaft 640x20x10	4
	H2	bolt M8x70	4
	H3A	plastic ring	4
	H3B	plastic ring	8
	H4	bolt M8x100	4
	H5	nut M8	8
	H6	noked Ø8	8
	H7	bolt M10x70	4
	H8	noked Ø10	4
	H9	T type leg	4
	H10	shaft	2
	H11	wheel	8
	H12	table tennis bat	2
	H13	table tennis net	1

# ASSEMBLY INSTRUCTIONS

- The packing can be divided into two parts. One packing is for table ,two groups of H type undercarriages&two pieces of connecting shafts for the purpose of joining two supporting frames.Another packing is for four groups of Ttype supporting frame assembled with wheels.
- DIRECTION OF INSTALLATION:**
  - Owing to the situation that the table is heavy,Person for installing or moving table should be two or more.
  - After open the carton,Please reverse the table and put down on the carton put on the ground.
  - Please take out two pieces of connecting shafts and release the bolts on both ends of the shaft.

## T002 TABLE TENNIS TABLE ASSEMBLY INSTRUCTIONS

H3 ATTENTION TO THE DIRECTION OF.

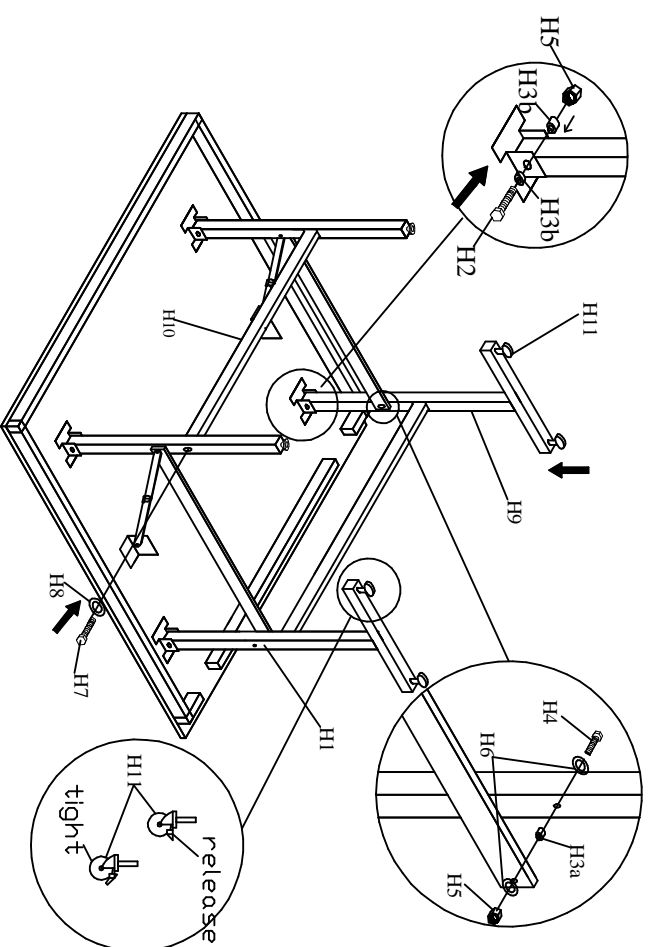

### WARNING:

Two adults needed to assemble table.

# ASSEMBLY INSTRUCTIONS

## FULL SIZE TABLE TENNIS TABLE ASSEMBLY INSTRUCTIONS

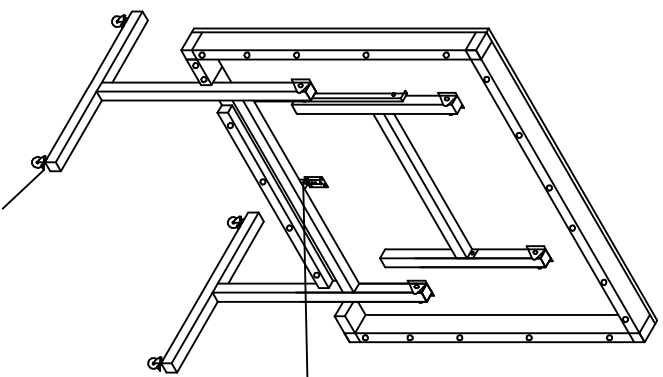





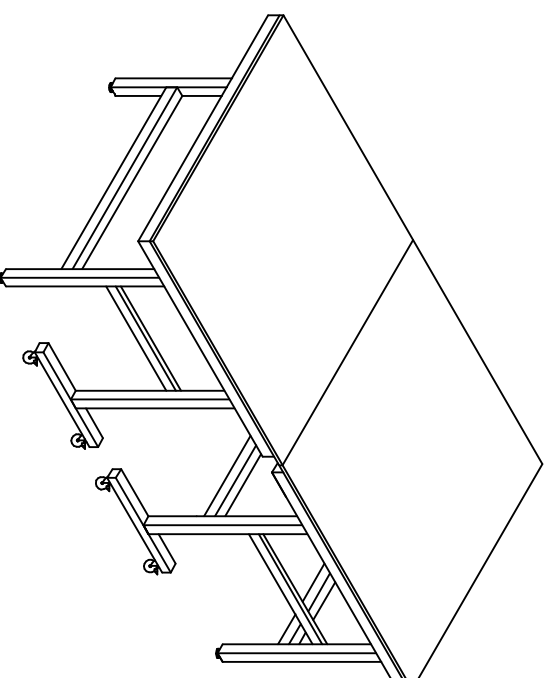



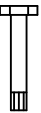

Please insert the safety rod  
after tolding up the table.

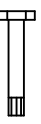
Please remember to lock the wheels.

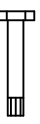

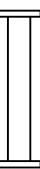
# PARTS IDENTIFIER

## HARDWARE

sketch	Index name	spec	quantity
	H1	shaft 640x20x10	4
	H2	bolt M8x50	4
	H3A	plastic ring	4
	H3B	plastic ring	8
	H4	bolt M8x70	4
	H5	nut M8	8
	H6	noked Ø8	8
	H7	bolt M10x45	4
	H8	noked Ø10	4
	H9	T type leg	4
	H10	shaft	2
	H11	wheel	8
	H12	table tennis bat	2
	H13	table tennis net	1

# ASSEMBLY INSTRUCTIONS

- The packing can be divided into two parts. One packing is for table ,two groups of H type undercarriages&two pieces of connecting shafts for the purpose of joining two supporting frames. Another packing is for four groups of T type supporting frame assembled with wheels.
- DIRECTION OF INSTALLATION:**
  - Owing to the situation that the table is heavy, Person for installing or moving table should be two or more.
  - After open the carton, Please reverse the table and put down on the carton put on the ground.
  - Please take out two pieces of connecting shafts and release the bolts on both ends of the shaft.

## T002 TABLE TENNIS TABLE ASSEMBLY INSTRUCTIONS

H3 ATTENTION TO THE DIRECTION OF.

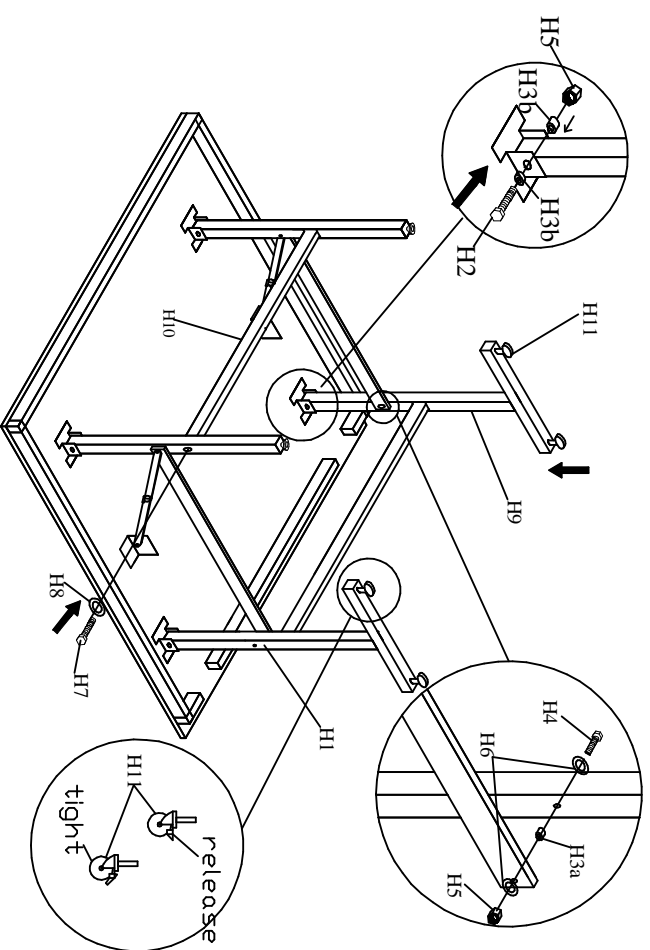

### WARNING:

Two adults needed to assemble table.

# ASSEMBLY INSTRUCTIONS

## FULL SIZE TABLE TENNIS TABLE ASSEMBLY INSTRUCTIONS

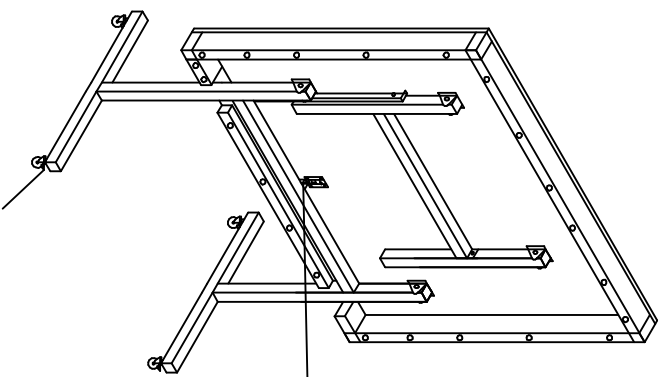





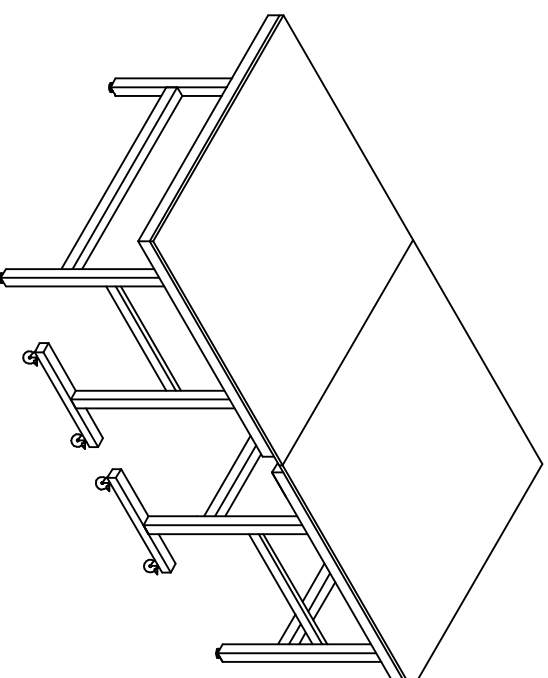

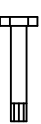

Please insert the safety rod  
after tolding up the table.

Please remember to lock the wheels.

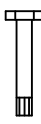

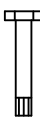
# PARTS IDENTIFIER

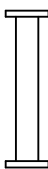
## HARDWARE

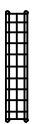
sketch	Index name	spec	quantity
	H1	shaft 640x20x10	4
	H2	bolt M8x60	4
	H3A	plastic ring	4
	H3B	plastic ring	8
	H4	bolt M8x90	4
	H5	nut M8	8
	H6	noked Ø8	8
	H7	bolt M10x55	4
	H8	noked Ø10	4
	H9	T type leg	4
	H10	shaft	2
	H11	wheel	8
	H12	table tennis bat	2
	H13	table tennis net	1

# ASSEMBLY INSTRUCTIONS

- The packing can be divided into two parts. One packing is for table ,two groups of H type undercarriages&two pieces of connecting shafts for the purpose of joining two supporting frames.Another packing is for four groups of Ttype supporting frame assembled with wheels.
- DIRECTION OF INSTALLATION:**
  - Owing to the situation that the table is heavy,Person for installing or moving table should be two or more.
  - After open the carton,Please reverse the table and put down on the carton put on the ground.
  - Please take out two pieces of connecting shafts and release the bolts on both ends of the shaft.

## T002 TABLE TENNIS TABLE ASSEMBLY INSTRUCTIONS

H3 ATTENTION TO THE DIRECTION OF.

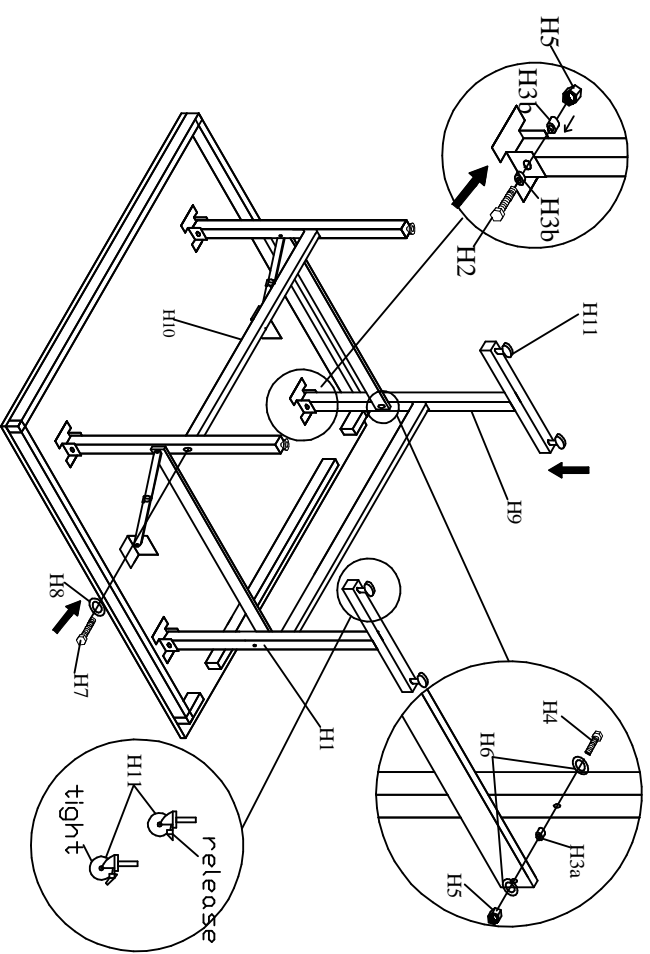

### WARNING:

Two adults needed to assemble table.

# ASSEMBLY INSTRUCTIONS

## FULL SIZE TABLE TENNIS TABLE ASSEMBLY INSTRUCTIONS

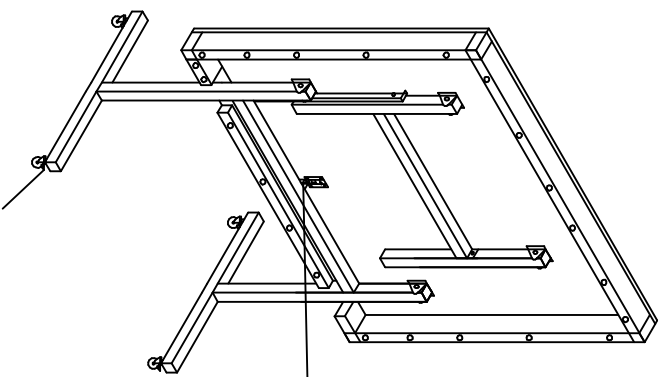

Please insert the safety rod  
after tolding up the table.

Please remember to lock the wheels.

