

Ref.1257_82362

NOTICE DE MONTAGE

NO.	1	2	3	4	5	5a	6	6a	7	7a	8	9	10	11	12	13	14	15	16	17	18
	5PCS	5PCS	10PCS	10PCS	5PCS	2PCS	5 PCS	2 PCS	10PCS	4PCS	4PCS	2PCS	2PCS	35PCS	4PCS	39PCS	1PC	1PC	12PCS	4PCS	1PC

Etape 1 :

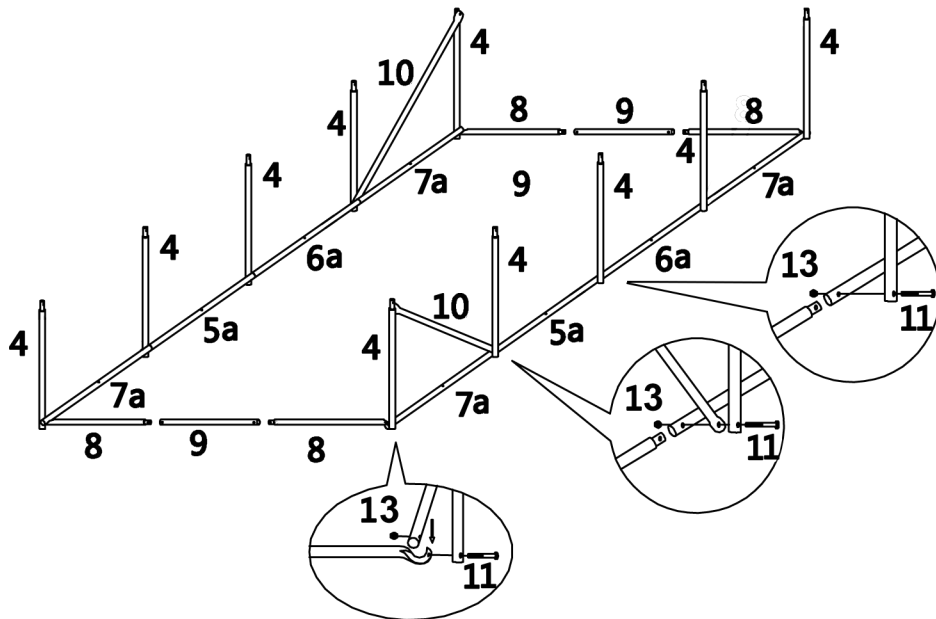

Serrer légèrement toutes les vis de la structure, puis serrer au maximum toutes les vis.

FR : SAV/INFORMATION /VIDEO/CONTACT
 GB : SAV/INFORMATION/VIDEO/CONTACT
 DE : KUNDENDIENST/INFORMATIONEN /VIDEO/KONTAKT
 ES : SERVICIO POST-VENTA/INFORMACION/VIDEO/CONTACTAR
 IT : SERVIZIO ASSISTENZA/INFORMAZIONI/VIDEO/CONTATTO
 PT : SERVIÇO PÓS-VENDA/INFORMAÇÕES/VIDEO/CONTATO
 PL : SERWIS TECHNICZNY/INFORMACJE/WIDEO/KONTAKT
 NE : AFTER SALES SERVICE/INFORMATIE/VIDEO/CONTACT
 HE : מע רשות/אודיווה/ עדימ/תוריקמו תוריש רחאל

www.gecodis.com

Ref.1257_82362

Etape 2 :

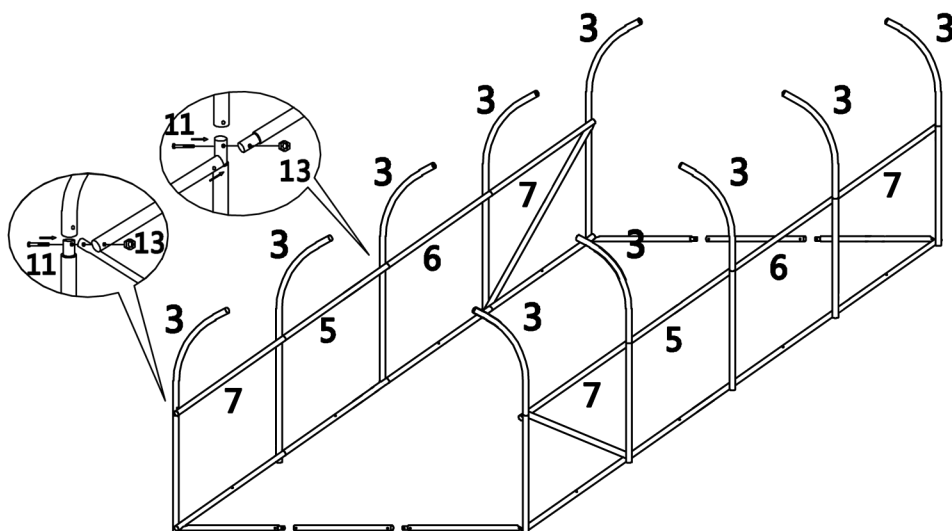

Serrer légèrement toutes les vis de la structure, puis serrer au maximum toutes les vis.

FR : SAV/INFORMATION /VIDEO/CONTACT
GB : SAV/INFORMATION/VIDEO/CONTACT
DE : KUNDENDIENST/INFORMATIONEN /VIDEO/KONTAKT
ES : SERVICIO POST-VENTA/INFORMACION/VIDEO/CONTACTAR
IT : SERVIZIO ASSISTENZA/INFORMAZIONI/VIDEO/CONTATTO
PT : SERVIÇO PÓS-VENDA/INFORMAÇÕES/VIDEO/CONTATO
PL : SERWIS TECHNICZNY/INFORMACJE/WIDEO/KONTAKT
NE : AFTER SALES SERVICE/INFORMATIE/VIDEO/CONTACT
HE : מע רשקתל/ואדייווה/ עדימ/תורכמו תוריש רחאל

www.gecodis.com

Ref.1257_82362

Etape 3 :

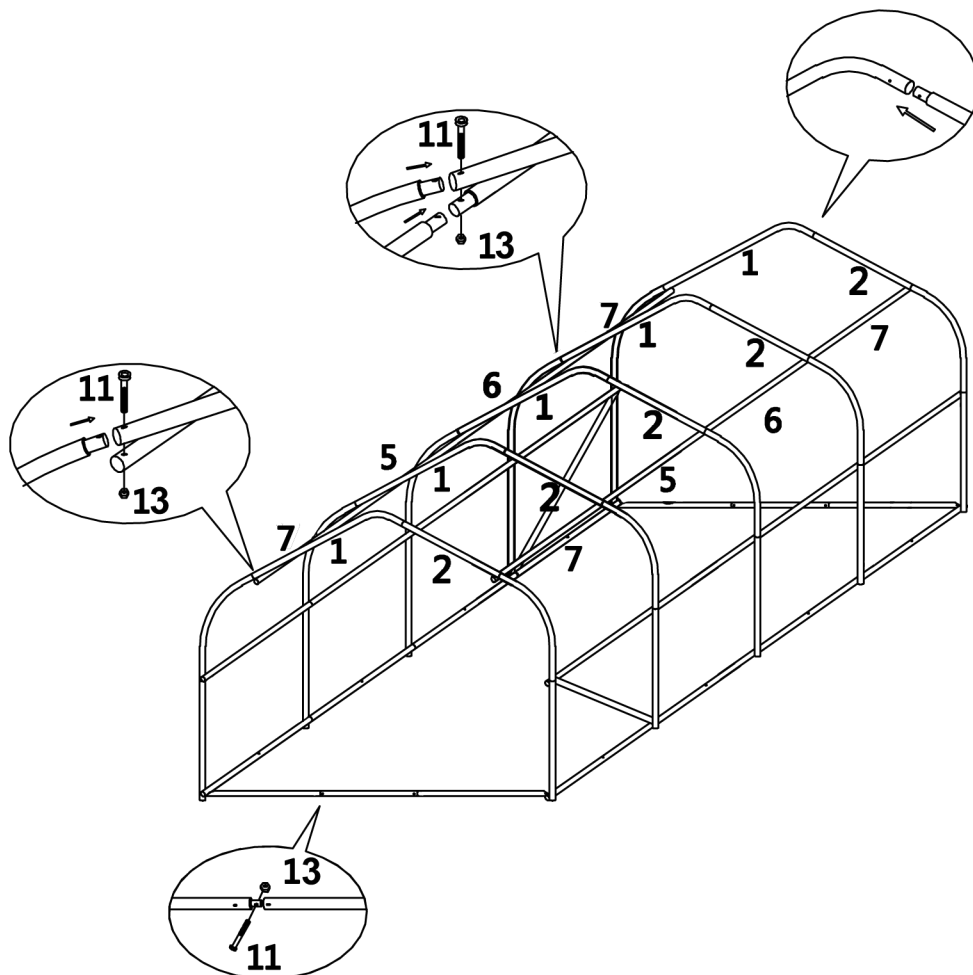

Serrer légèrement toutes les vis de la structure, puis serrer au maximum toutes les vis.

FR : SAV/INFORMATION /VIDEO/CONTACT
GB : SAV/INFORMATION/VIDEO/CONTACT
DE : KUNDENDIENST/INFORMATIONEN /VIDEO/KONTAKT
ES : SERVICIO POST-VENTA/INFORMACIÓN/VIDEO/CONTACTAR
IT : SERVIZIO ASSISTENZA/INFORMAZIONI/VIDEO/CONTATTO
PT : SERVIÇO PÓS-VENDA/INFORMAÇÕES/VIDEO/CONTATO
PL : SERWIS TECHNICZNY/INFORMACJE/WIDEO/KONTAKT
NE : AFTER SALES SERVICE/INFORMATIE/VIDEO/CONTACT
HE : פוע רשקתל/ואדיווה/ עדימ/תורינו תוריש רחאל

www.gecodis.com

Etape 4 :

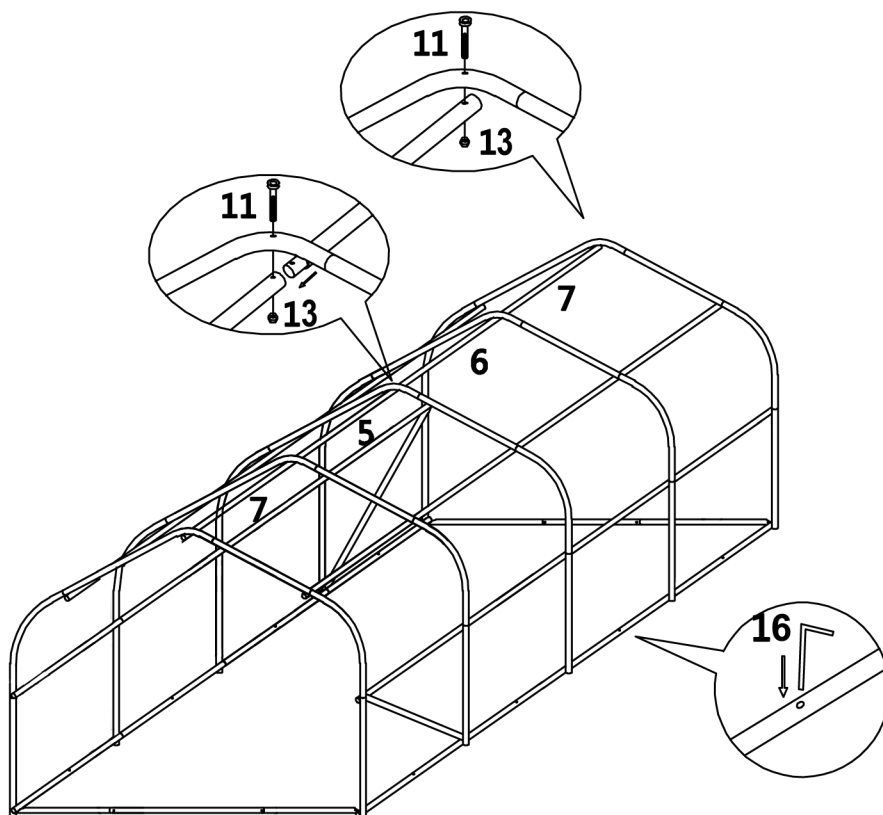





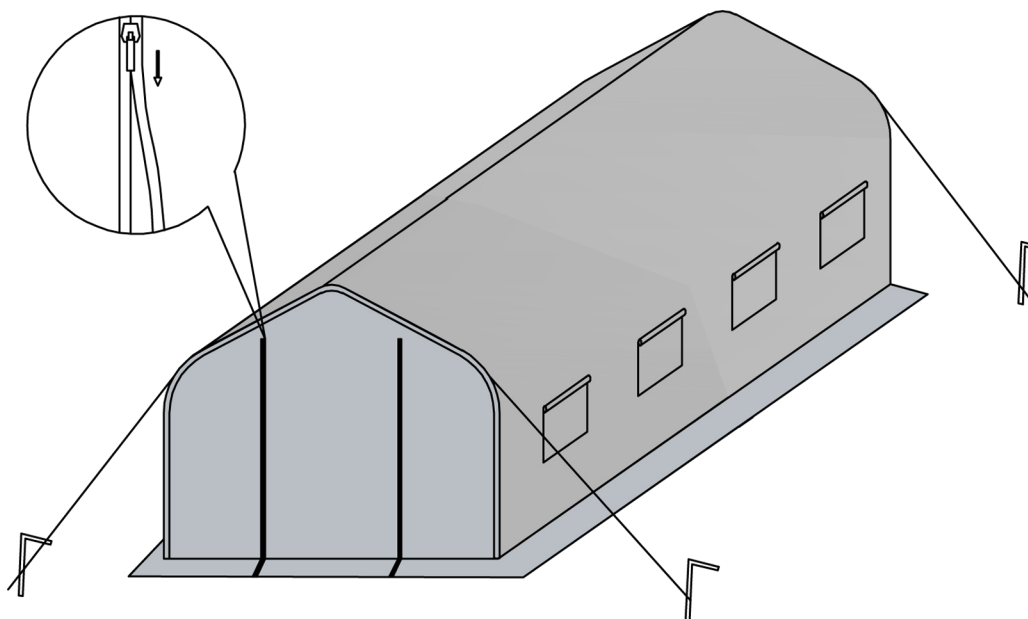





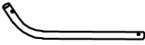
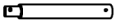

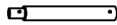





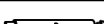

Serrer légèrement toutes les vis de la structure, puis serrer au maximum toutes les vis.

Etape 5 :



Remarque:

- **Veillez lire attentivement les instructions de montage**
- **2 ou 3 personnes nécessaires au montage**
- **Pour une stabilité maximum, veuillez creuser une tranchée autour de la serre, y-déposer le film plastique et recouvrir de terre**

SCHEMA	N°	DIMENSION (mm)	Qté
	1	1120	5PCS
	2	920	5PCS
	3	1100	10PCS
	4	800	10PCS
	5	990	5PCS
	5a	990	2PCS
	6	1040	5PCS
	6a	1040	2PCS
	7	1040	10PCS
	7a	1040	4PCS
	8	1030	4PCS
	9	990	2PCS
	10	1290	2PCS
	11	M6x58	35PCS
	12	M6x30	4PCS
	13		39PCS
	14	66	1PC
	15	73	1PC
	16	170	12PCS
	17	2400	4PCS
	18		1PC