

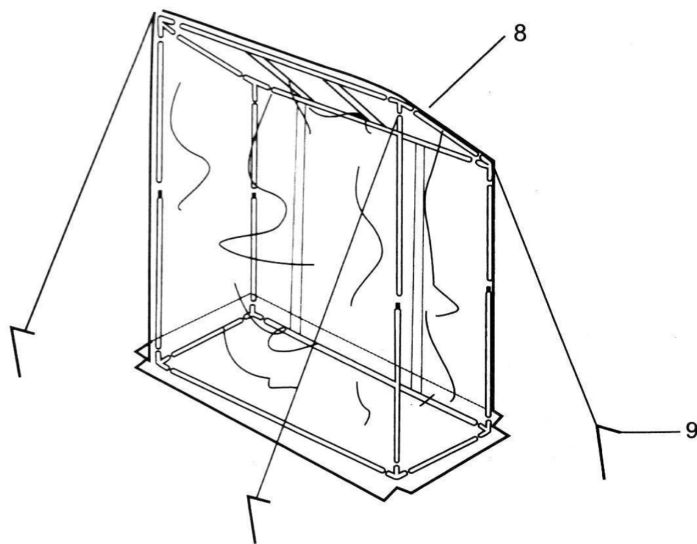

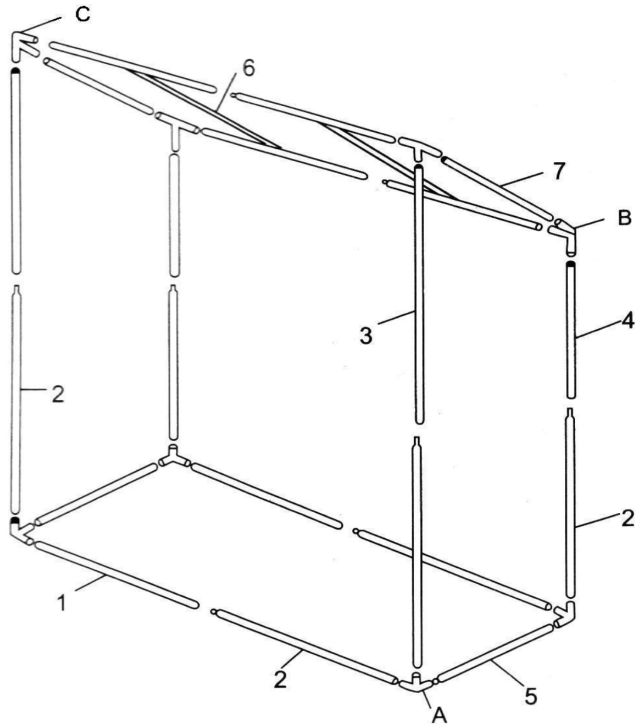









# NOTICE DE MONTAGE



No.	PICTURE	QTY
1		4
2		8
3		2
4		2
5		2
6		2
7		2
A		4
B		2
C		2
8		1
9		4

FR : SAV/INFORMATION /VIDEO/CONTACT  
 GB: SAV/INFORMATION/VIDEO/CONTACT  
 ALLEMAND : KUNDENDIENST/Informationen /VIDEO/KONTAKT  
 ES: SERVICIO POST-VENTA/INFORMACIÓN/VIDEO/CONTACTAR  
 IT: SERVIZIO ASSISTENZA/INFORMAZIONI/VIDEO/CONTATTO  
 PT: SERVIÇO PÓS-VENDA/INFORMAÇÕES/VIDEO/CONTATO  
 PL: SERWIS TECHNICZNY/INFORMACJE/WIDEO/KONTAKT  
 NE: AFTER SALES SERVICE/INFORMATIE/VIDEO/CONTACT  
 HEBREU : מע רשקתל/ואדיווה/ עדימ/תורכמו תוריש רחאל

SCHEMA	N°	DIMENSION (mm)	Qté
	<b>1</b>	<b>980</b>	<b>4</b>
	<b>2</b>	<b>980</b>	<b>8</b>
	<b>3</b>	<b>690</b>	<b>2</b>
	<b>4</b>	<b>500</b>	<b>2</b>
	<b>5</b>	<b>720</b>	<b>2</b>
	<b>6</b>	<b>740</b>	<b>2</b>
	<b>7</b>	<b>740</b>	<b>2</b>
	<b>A</b>		<b>4</b>
	<b>B</b>		<b>2</b>
	<b>C</b>		<b>2</b>
	<b>8</b>		<b>1</b>
	<b>9</b>	<b>170</b> <b>2400</b>	<b>4</b>

FR : SAV/INFORMATION /VIDEO/CONTACT  
 GB: SAV/INFORMATION/VIDEO/CONTACT  
 ALLEMAND : KUNDENDIENST/Informationen /VIDEO/KONTAKT  
 ES: SERVICIO POST-VENTA/INFORMACIÓN/VIDEO/CONTACTAR  
 IT: SERVIZIO ASSISTENZA/INFORMAZIONI/VIDEO/CONTATTO  
 PT: SERVIÇO PÓS-VENDA/INFORMAÇÕES/VIDEO/CONTATO  
 PL: SERWIS TECHNICZNY/INFORMACJE/WIDEO/KONTAKT  
 NE: AFTER SALES SERVICE/INFORMATIE/VIDEO/CONTACT  
 HEBREU : סע רשקתל/ואדיווה/ עדימ/תוריקמו תוריש רחאל :